

1-PHASE

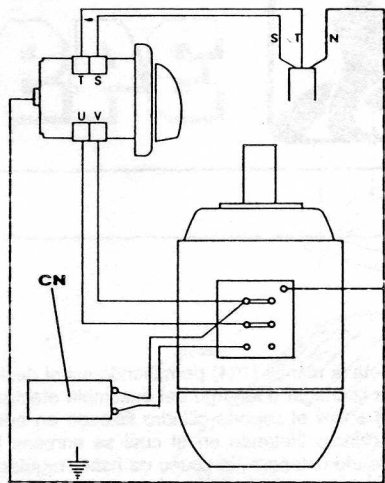

FIG. 3

3-PHASE

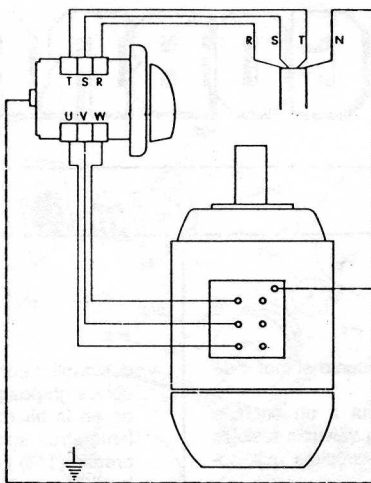

FIG. 4

COLLEGAMENTO ELETTRICO
per macchine di serie

ELECTRICAL CONNECTION
for standard machine

BRANCHEMENT
pour machine standard

ELEKTROANSCHLUSS
für Standard Maschine

CONEXION ELECTRICA
para máquinas standard

1-PHASE

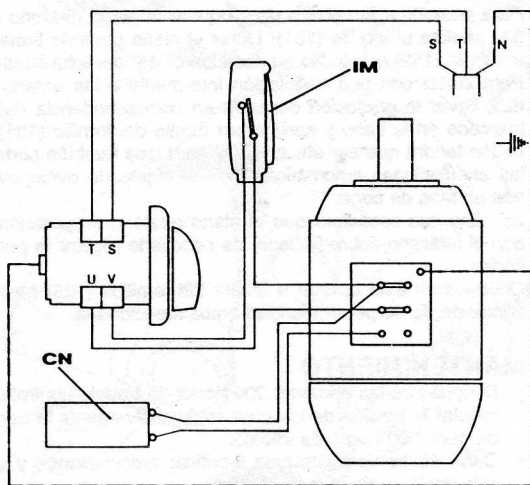

FIG. 5

COLLEGAMENTO ELETTRICO
con interruttore sull'impugnatura

ELECTRICAL CONNECTION
with the switch on the handle

BRANCHEMENT
avec l'interrupteur sur la poignée

ELEKTROANSCHLUSS
mit Schalter auf dem Handgriff

CONEXION ELECTRICA
con el interruptor en la empuñadura

3-PHASE

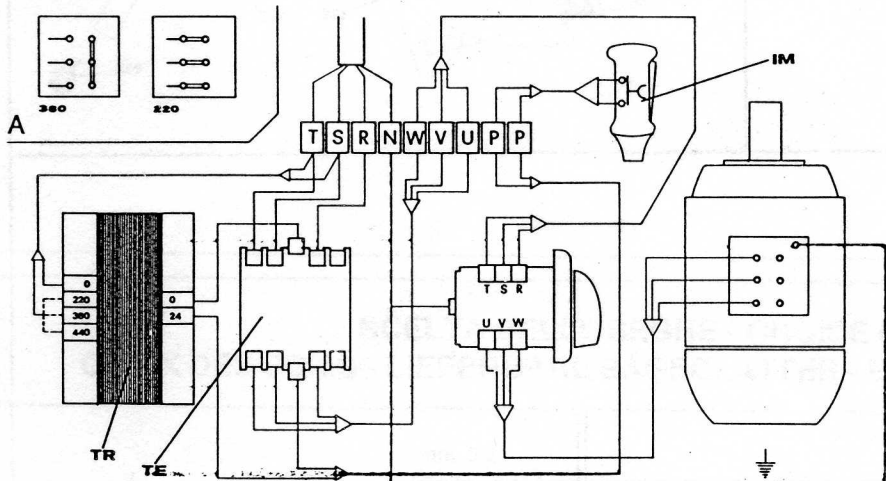

FIG. 6

COLLEGAMENTO ELETTRICO
con dispositivo a bassa tensione volts 24

ELECTRICAL CONNECTION
with low tension device volts 24

BRANCHEMENT
avec dispositif à basse tension volts 24

ELEKTROANSCHLUSS
mit Vorrichtung bei Niederspannung 24 Volt

CONEXION ELECTRICA
con dispositivo a baja tensión volts 24

			d = 350				
a	d						
32	350		90°	120	110	160x100	280x90
		45°	120	105	110x105	190x90	150x100

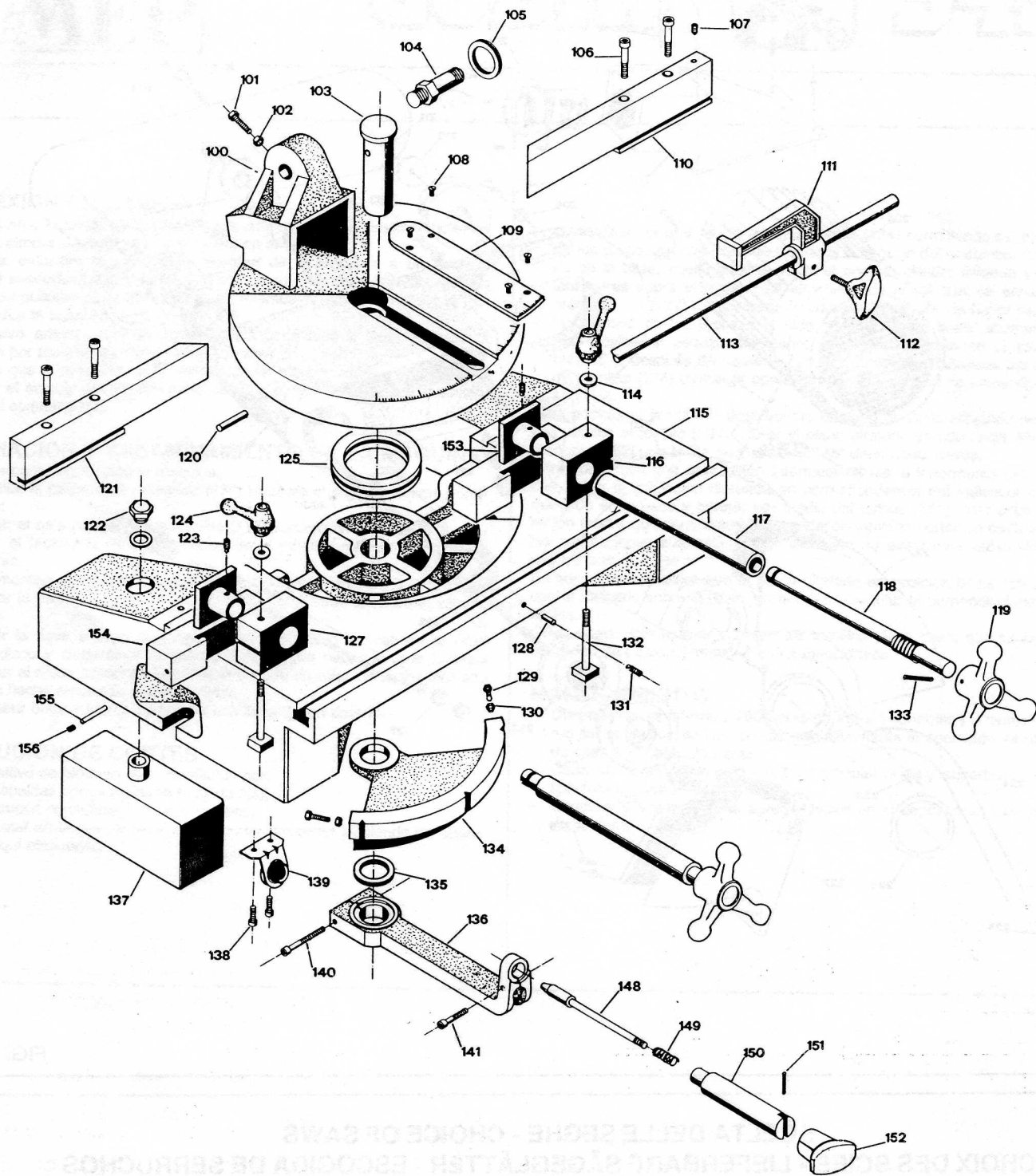
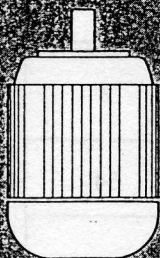
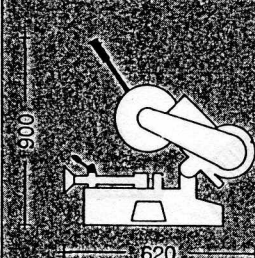
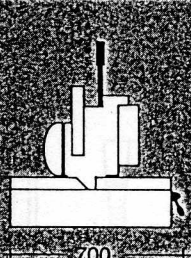
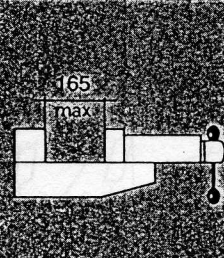

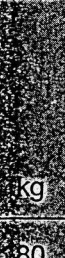

FIG. 2

	1-PHASE	3-PHASE	 		
					
	HP 1.5 RPM 3400	HP 1.5 RPM 3400			Kg 30

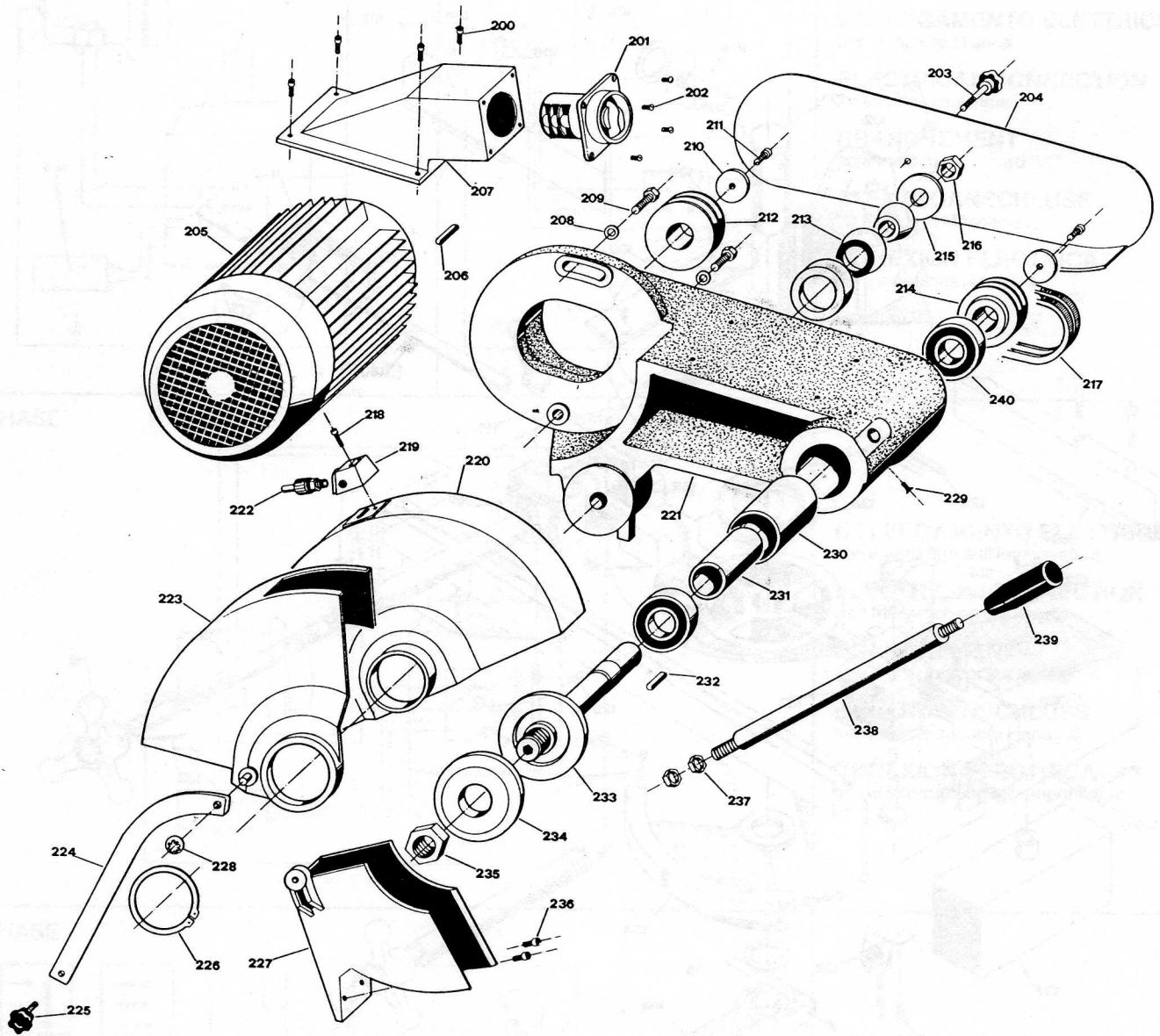
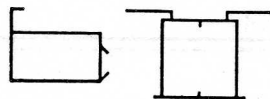
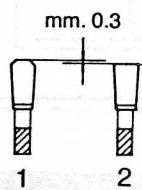
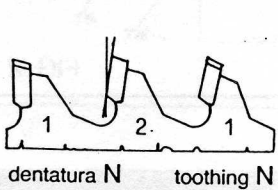

FIG. 1

SCELTA DELLE SEGHE - CHOICE OF SAWS
CHOIX DES SCIES - LIEFERBARE SÄGEGLÄTTER - ESCOGIDA DE SERRUCHOS



dentatura
toothing

∅ disco-blade

Z

N

350

84

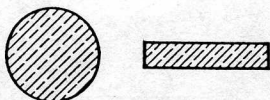
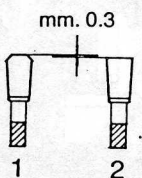
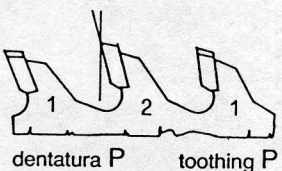

dentatura
toothing

∅ disco-blade

Z

P

350

84