

Explosietekeningen

In het nu volgende deel zijn de explosietekeningen van de machine opgenomen. De tekeningen met hun volledige details kunnen helpen de machine beter te leren kennen.

Motorgroep

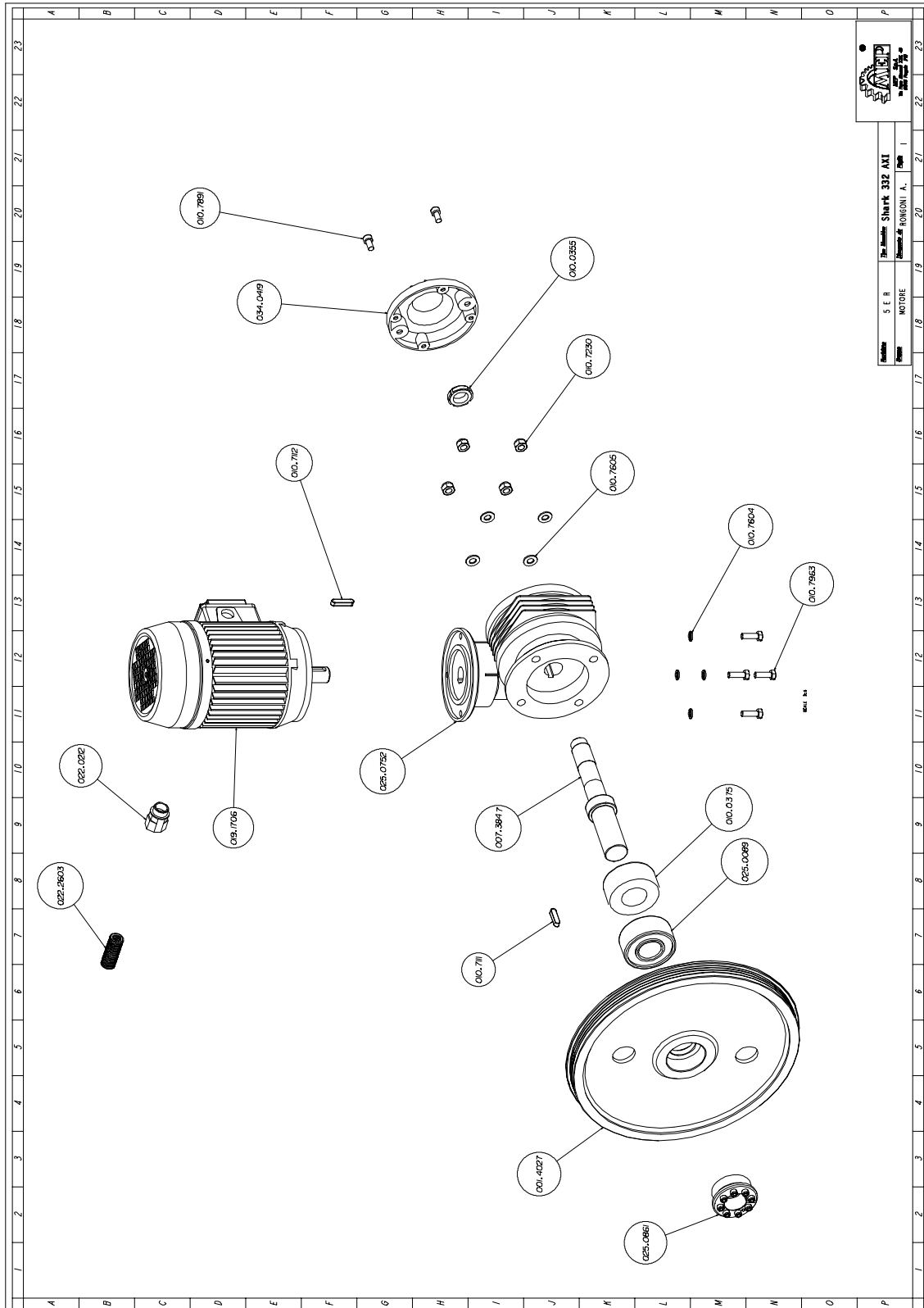

Art. nr.	Benaming	M.	Hoeveelheid
001.4027	PULEGGIA MOTRICE	NR	1,000
007.3847	ALBERO RIDUTTORE SH 320	NR	1,000
010.0355	GHIERA AUTOBLOCCANTE 25X1,5	NR	1,000
010.0375	GHIERA FISSAGGIO ALBERO RIDUTTORE	NR	1,000
010.7111	CHIAVETTA 8 X 7 X 32	NR	1,000
010.7112	CHIAVETTA 8 X 7 X 35	NR	1,000
010.7230	DADO AUTOBLOCCANTE M10	NR	4,000
010.7604	RONDELLA DIAM. 8	NR	4,000
010.7605	RONDELLA DIAM. 10	NR	4,000
010.7871	VITE TCEI 6 X 20	NR	8,000
010.7891	VITE TCEI 8 X 16	NR	2,000
010.7963	VITE TE 8 X 25	NR	4,000
019.1706	HP 2/2,5 2/4P V.380 B14 FC90L	NR	1,000
022.0212	RACCORDO RAPIDO SEM PG 16	NR	1,000
022.2603	GUAINA POLIFLEX NW 17-1200178	MT	1,000
025.0089	CUSCINETTO 3307 A2RS	NR	1,000
025.0752	RIDUTTORE MVF 72 SH 320	NR	1,000
025.0861	CALETTATORE 0 35X60	NR	1,000
034.0419	COPERCHIO RIDUTTORE SH 320	NR	1,000

Afdekking zaagbeugel

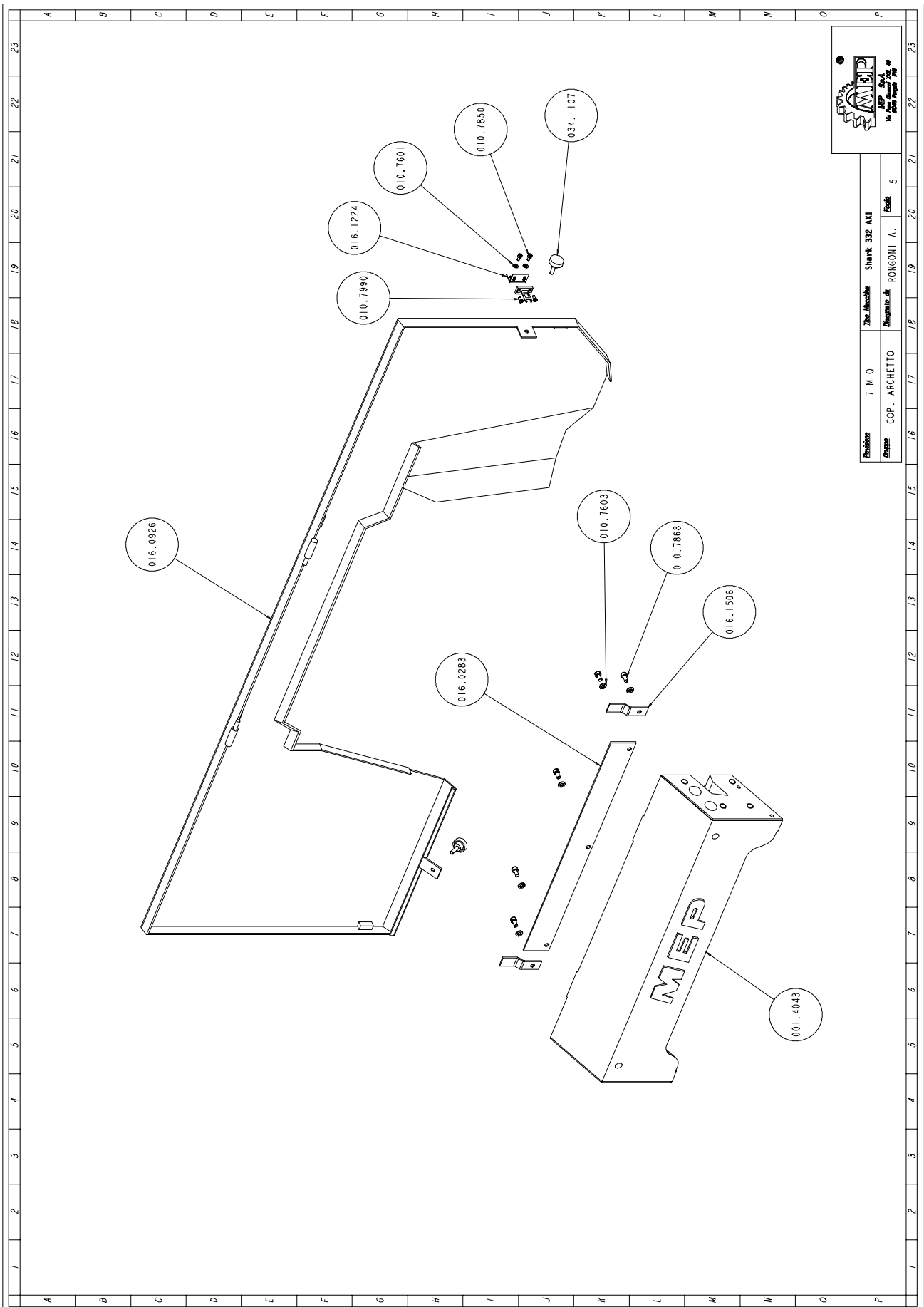

Revisie	7 M O	Ziv. Macchine	Shark 332 AXI
Disegn.	COP. ARCHETTO	Disegnato da	RONGONI A.
		Foglio	5

Art. nr.	Benaming	M.	Hoeveelheid
001.4043	TRAVE ARCHETTO SH 332	NR	1,000
010.7601	RONDELLA DIAM. 4	NR	2,000
010.7603	RONDELLA DIAM. 6	NR	5,000
010.7850	VITE TCEI 4 X 8	NR	2,000
010.7868	VITE TCEI 6 X 12	NR	5,000
010.7990	VITE TSPEI 4 X 8	NR	2,000
016.0283	PROTEZIONE CAVI	NR	1,000
016.0926	COPERCHIO ARCHETTO SH 332	NR	1,000
016.1224	PIASTR.FIX INTER.SICUR.COPERCHIO	NR	1,000
016.1506	STAFFA DI FERMO	NR	2,000
034.1107	VOLANTINO DIAM.30 M6 X 20	NR	2,000

Doorsnede loopwiel

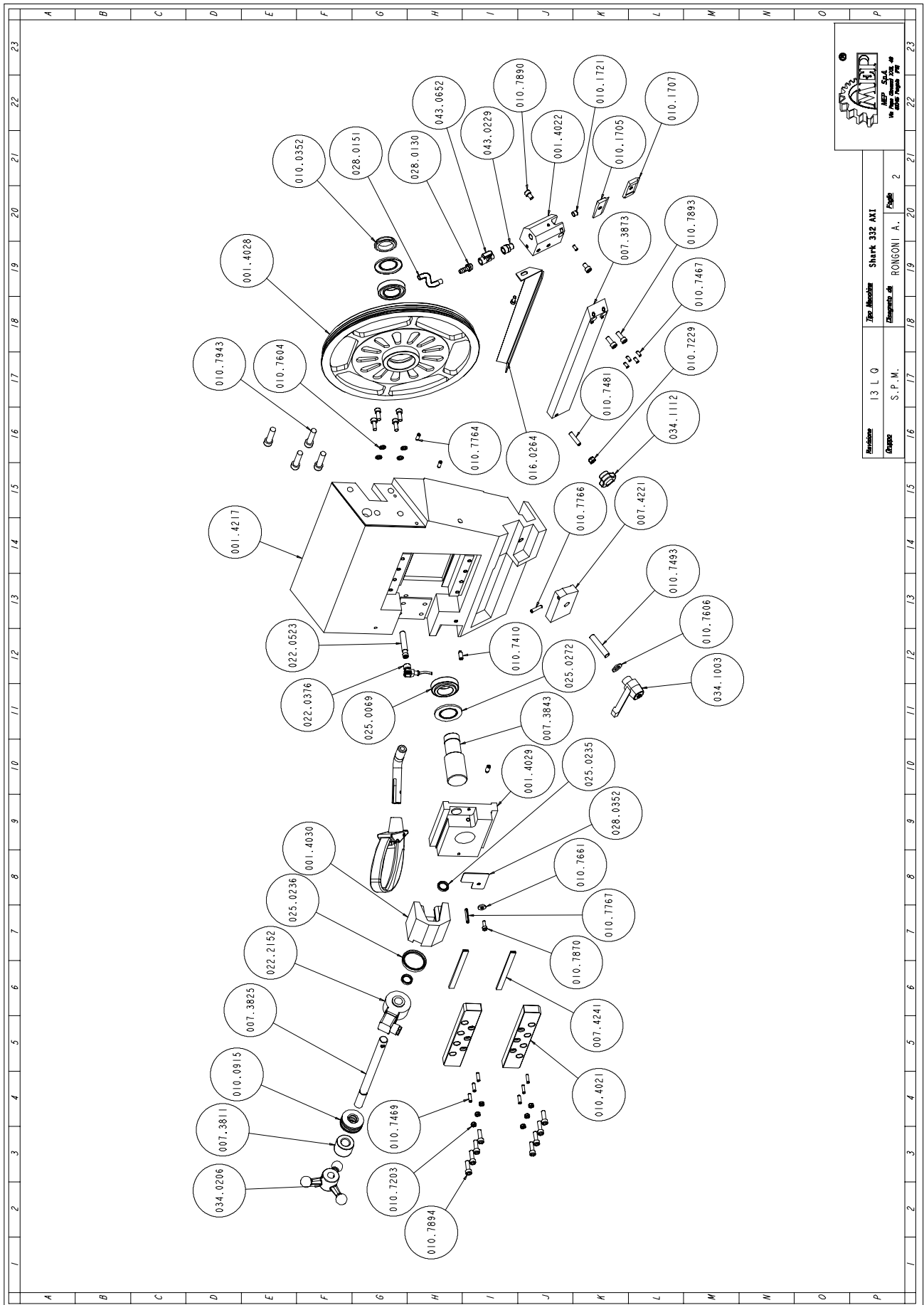

Art. nr.	Benaming	M.	Hoeveelheid
001.4022	TESTINA GUIDALAMA ANTERIORE	NR	1,000
001.4028	PULEGGIA FOLLE ARCHETTO	NR	1,000
001.4029	SLITTA TENDILAMA ARCHETTO	NR	1,000
001.4030	SUPPORTO TENSIONAMENTO LAMA ELETTR.	NR	1,000
001.4217	ARCHETTO SEZIONE PULEGGIA FOLLE	NR	1,000
007.3811	DISTANZIALE VOLANTINO	NR	1,000
007.3825	PERNO REGISTRO TENSIONAMENTO LAMA	NR	1,000
007.3843	ALBERO VOLANO LIBERO	NR	1,000
007.3873	SUPPORTO TESTINA ANTERIORE	NR	1,000
007.4221	STAFFA BLOCCAGGIO GUIDA TESTINA	NR	1,000
007.4241	LARDONE SLITTA TENDILAMA	NR	2,000
010.0352	GHIERA AUTOBLOCCANTE 35X1,5	NR	1,000
010.0915	MOLLA A TAZZA	NR	4,000
010.0928	MOLLA X IMPUGNATURA	NR	1,000
010.1705	GUIDALAMA 1 INSERTO ANTERIORE	NR	1,000
010.1707	GUIDALAMA 2 INSERTI ANTERIORE	NR	1,000
010.1721	PREMILAMA	NR	1,000
010.1910	LEVA COMANDO TESTA BT	NR	1,000
010.4021	PIASTRA REGOLAZIONE SLITTA LARDONE	NR	2,000
010.7203	DADO M6	NR	6,000
010.7229	DADO AUTOBLOCCANTE M8	NR	1,000
010.7409	GRANO VCE P.CIL. 8 X 10	NR	1,000
010.7410	GRANO VCE P.CIL. 8 X 16	NR	2,000
010.7467	GRANO VCE PUNTA PIANA 6 X 12	NR	5,000
010.7469	GRANO VCE PUNTA PIANA 6 X 20	NR	6,000
010.7481	GRANO VCE PUNTA PIANA 8 X 35	NR	1,000
010.7493	GRANO VCE PUNTA PIANA 12 X 60	NR	1,000
010.7604	RONDELLA DIAM. 8	NR	4,000
010.7606	RONDELLA DIAM. 12	NR	1,000
010.7661	RONDELLA SPESSORE DIAM. 6 X 3	NR	1,000
010.7700	SPINA CILINDRICA DIAM. 4 X 24	NR	1,000
010.7764	SPINA ELASTICA DIAM. 6 X 20	NR	2,000
010.7766	SPINA ELASTICA DIAM. 6 X 30	NR	1,000
010.7767	SPINA ELASTICA DIAM. 6 X 35	NR	1,000
010.7802	VITE AUTOFILETTANTE 3,9 X 16	NR	3,000
010.7870	VITE TCEI 6 X 16	NR	2,000
010.7890	VITE TCEI 8 X 12	NR	2,000
010.7893	VITE TCEI 8 X 20	NR	6,000
010.7894	VITE TCEI 8 X 25	NR	8,000
010.7943	VITE TCEI 12 X 45	NR	4,000
016.0264	PROTEZIONE LAMA ANTERIORE	NR	1,000
022.0376	CONNETTORE F303N5000 X PROXIMITY	NR	1,000
022.0515	MICROINTERRUTTORE V-21-1C6	NR	1,000
022.0523	SENSORE DI PROSSIMITA' PNP	NR	1,000
022.2152	TENSIONATORE ELETTRONICO 02	NR	1,000
025.0069	CUSCINETTO 32007X	NR	2,000
025.0235	ANELLO TENUTA NI 150 18-25-4,5	NR	2,000
025.0236	ANELLO DI TENUTA NI 150 45-55-7	NR	1,000
025.0272	ANELLO DI PROTEZIONE NILOS 32007	NR	2,000
025.0691	SERIE GUARNIZIONI X IMPUGNATURA MEP	NR	3,000
028.0130	RACCORDO 1/4-9 CL 2601	NR	1,000
028.0151	TUBO PLASTIFICATO 07-11	MT	1,000
028.0352	PROTEZIONE GOMMA SLITTA TENDILAMA	NR	1,000
034.0206	VOLANTINO TENSIONAMENTO LAMA	NR	1,000
034.1003	LEVA A SCATTO 12 MA	NR	1,000
034.1112	VOLANTINO DIAM.40 M8	NR	1,000
034.1221	IMPUGNATURA DIS. MEP	NR	3,000
043.0229	RIDUZIONE MF 1/4 - CL 2520	NR	1,000
043.0652	RUBINETTO 1/4 F.M.	NR	1,000
090.0271	IMPUGNATURA COMPLETA TIPO MEP	NR	1,000

Doorsnede aandrijf wiel

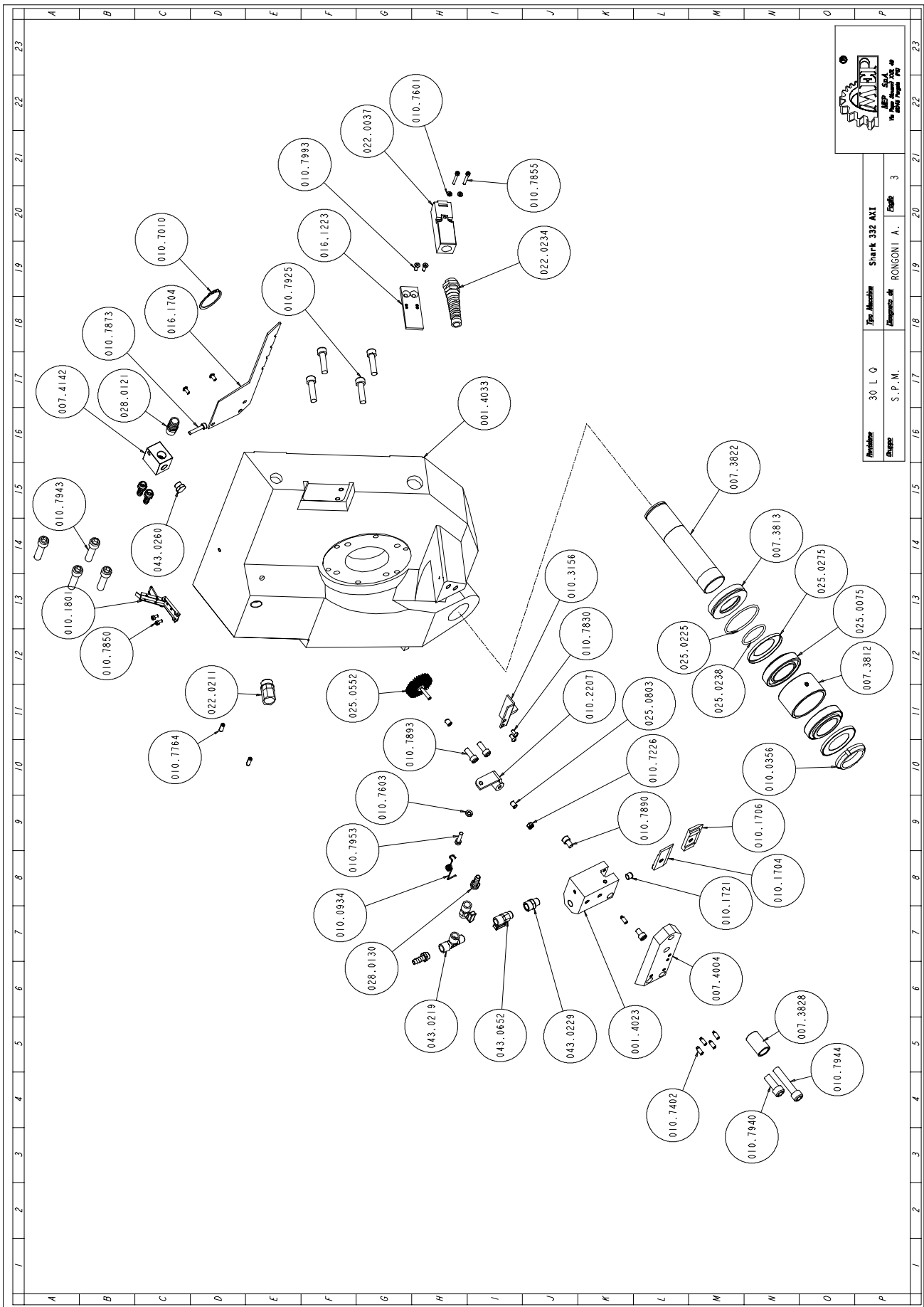

Revisie:	30 L Q	Type Machine:	Shark 332 AXI
Chassis:	S.P.M.	Diagramma Nr:	RONGONI A.
		Foglio:	3

Art. nr.	Benaming	M.	Hoeveelheid
001.4023	TESTINA GUIDALAMA POSTERIORE	NR	1,000
001.4033	ARCHETTO SEZ.PULEGGIA MOTRICE S/R	NR	1,000
007.3812	DISTANZIALE CUSCINETTO SNODO TESTA	NR	1,000
007.3813	DISTANZIALE ARCHETTO	NR	1,000
007.3822	PERNO SUPPORTO SNODO TESTA	NR	1,000
007.3828	BOCCOLA BATTUTA FINE CORSA	NR	1,000
007.4004	STAFFA TESTINA GUIDALAMA POSTERIORE	NR	1,000
007.4142	SQUADRETTO PER LIQUIDO	NR	1,000
010.0356	GHIERA AUTOBLOCCANTE 45X1,5	NR	1,000
010.0934	MOLLA X PULILAMA	NR	1,000
010.1704	GUIDALAMA 1 INSERTO POSTERIORE	NR	1,000
010.1706	GUIDALAMA 2 INSERTI POSTERIORE	NR	1,000
010.1721	PREMILAMA	NR	1,000
010.1801	CHIUSURA LEVA "D" ZINCATA	NR	1,000
010.2207	PORTASPAZZOLA PULILAMA SH 320 N.T.	NR	1,000
010.3156	STAFFA FIX SPAZZOLA PULILAMA	NR	1,000
010.7010	ANELLO SEEGER DIAM. 45 US.010.1201	NR	1,000
010.7226	DADO AUTOBLOCCANTE M6	NR	1,000
010.7402	GRANO VCE P.CIL. 6 X 12	NR	5,000
010.7601	RONDELLA DIAM. 4	NR	2,000
010.7603	RONDELLA DIAM. 6	NR	1,000
010.7764	SPINA ELASTICA DIAM. 6 X 20	NR	2,000
010.7830	VITE BUTON 5 X 10	NR	4,000
010.7850	VITE TCEI 4 X 8	NR	2,000
010.7855	VITE TCEI 4 X 30	NR	2,000
010.7873	VITE TCEI 6 X 30	NR	1,000
010.7890	VITE TCEI 8 X 12	NR	2,000
010.7893	VITE TCEI 8 X 20	NR	2,000
010.7925	VITE TCEI 10 X 40	NR	4,000
010.7940	VITE TCEI 12 X 30	NR	1,000
010.7943	VITE TCEI 12 X 45	NR	4,000
010.7944	VITE TCEI 12 X 60	NR	1,000
010.7953	VITE TE 6 X 25	NR	1,000
010.7993	VITE TSPEI 5 X 12	NR	2,000
016.1223	PIASTR.FIX INTERR.SICUR.ARCHETTO	NR	1,000
016.1704	PROTEZIONE LAMA POSTERIORE SH 320	NR	1,000
022.0037	INTERRUTTORE DI SICUREZZA FR 690	NR	1,000
022.0211	RACCORDO RAPIDO SEM PG 13,5	NR	1,000
022.0234	PRESSACORDONE 3246 NERO PG 13,5	NR	1,000
025.0075	CUSCINETTO 32009X	NR	2,000
025.0225	ANELLO TENUTA OR 171-68,26	NR	1,000
025.0238	ANELLO DI TENUTA OR 44.45X3,53	NR	1,000
025.0275	ANELLO DI PROTEZIONE NILOS 32009X	NR	2,000
025.0552	SPAZZOLA PULILAMA 6X25 030 GG53	NR	1,000
025.0803	BOCCOLA GRAFITATA L. 10 DIAM. 6	NR	2,000
028.0121	RACCORDO 3/8-17 CL 2601	NR	1,000
028.0130	RACCORDO 1/4-9 CL 2601	NR	4,000
043.0219	RACCORDO A" T" MFF 1/4" CL-2070	NR	1,000
043.0229	RIDUZIONE MF 1/4 - CL 2520	NR	1,000
043.0260	TAPPO TTE4 1/4 - CL 2611	NR	1,000
043.0652	RUBINETTO 1/4 F.M.	NR	2,000

Klemgroep

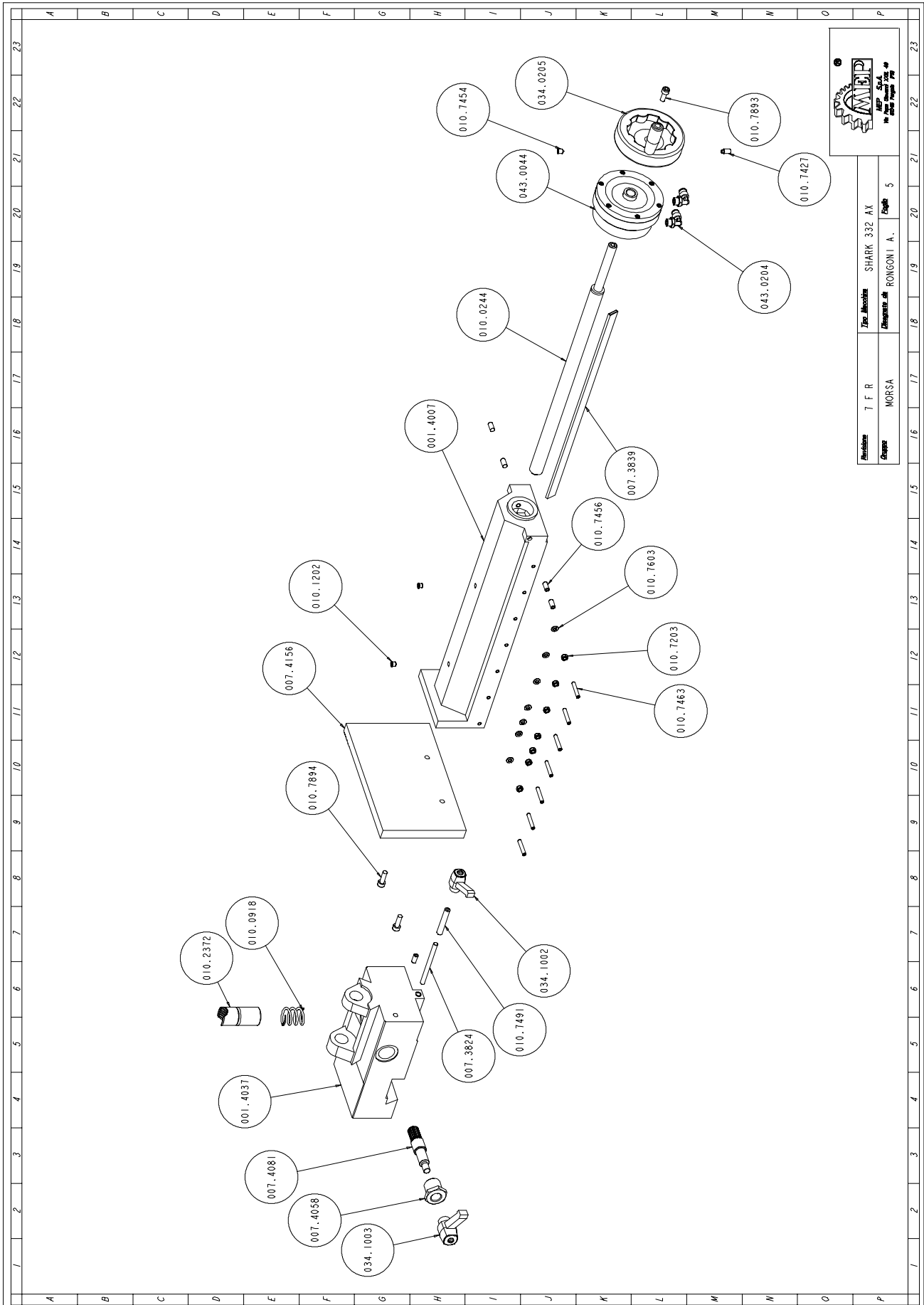

Art. nr.	Benaming	M.	Hoeveelheid
001.4007	SCORREVOLE MORSA	NR	1,000
001.4037	SUPPORTO MORSA	NR	1,000
007.3824	PERNO BLOCCAGGIO MORSA MSR	NR	1,000
007.3839	LARDONE MORSA	NR	1,000
007.4058	BOCCOLA ECCENTRICA	NR	1,000
007.4081	PIGNONE SBLOCCAGGIO SCORREVOLE	NR	1,000
007.4156	GANASCIA MORSA MOBILE SH 331	NR	1,000
010.0244	VITE MORSA	NR	1,000
010.0918	MOLLA RICHIAMO CHIOCC.VITE MORSA	NR	1,000
010.1202	OLIATORE A SFERA DIAM. 8	NR	2,000
010.2372	CHIOCCIOLA BRONZO 60Ø	NR	1,000
010.7203	DADO M6	NR	7,000
010.7427	GRANO VCE P.CIL. 8 X 12	NR	1,000
010.7454	GRANO VCE P.CON. 8 X 8	NR	1,000
010.7456	GRANO VCE P.CON. 8 X 16	NR	5,000
010.7463	GRANO VCE P.CON. 6 X 35	NR	7,000
010.7491	GRANO VCE PUNTA PIANA 10 X 60	NR	1,000
010.7603	RONDELLA DIAM. 6	NR	7,000
010.7859	VITE TCEI 5 X 12	NR	4,000
010.7893	VITE TCEI 8 X 20	NR	1,000
010.7894	VITE TCEI 8 X 25	NR	6,000
025.0203	ANELLO TENUTA 35X25X7	NR	2,000
025.0452	RULLI 6X6 AISI 420	NR	1,000
034.0205	VOLANTINO VPRA/125 MR	NR	1,000
034.1002	LEVA A SCATTO 10 MA	NR	1,000
034.1003	LEVA A SCATTO 12 MA	NR	1,000
043.0204	ATTACCAGOMITO 8 X 1/4	NR	2,000
043.0044	CILINDRO VOLAMPRESS	NR	1,000
090.5201	PARTICOLARI	NR	2,000

Groep vaste tafel

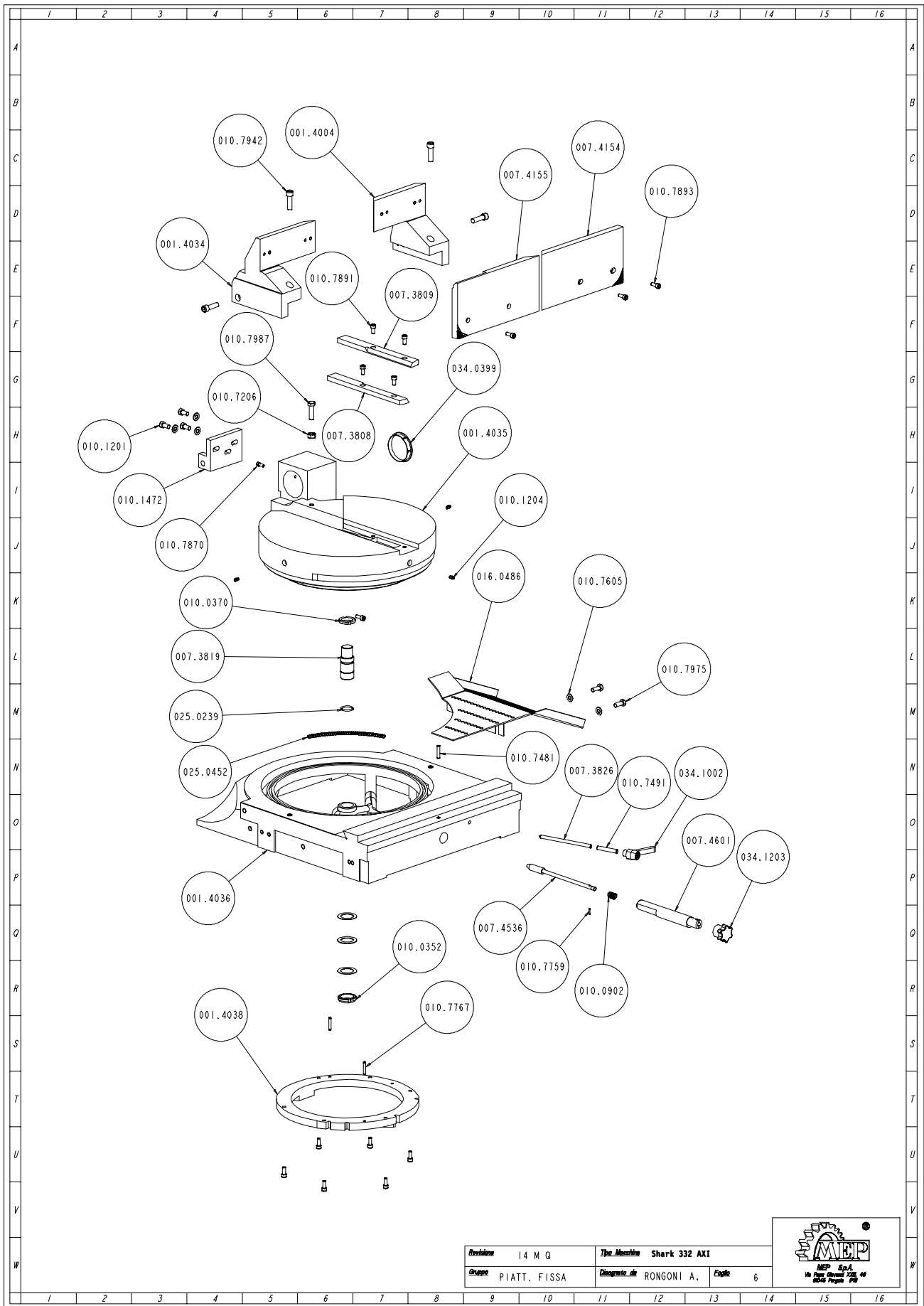

Art. nr.	Benaming	M.	Hoeveelheid
001.4004	SQUADRO MORSA DESTRO	NR	1,000
001.4034	SQUADRO MORSA SX	NR	1,000
001.4035	PIANO GIREVOLE SH	NR	1,000
001.4036	PIATTAFORMA FISSA	NR	1,000
001.4038	ANELLO PIANO GIREVOLE 60Ø	NR	1,000
007.3808	PIASTRA APPOGGIA PEZZI SINISTRA	NR	1,000
007.3809	PIASTRA APPOGGIA PEZZI DESTRA	NR	1,000
007.3819	PERNO DI CENTRO	NR	1,000
007.3826	PERNO BLOCC.PIANO GIREVOLE	NR	1,000
007.4154	GANASCIA MORSA DESTRA SH 331	NR	1,000
007.4155	GANASCIA MORSA SINISTRA SH 331	NR	1,000
007.4536	PERNO PUNTO FISSO	NR	1,000
007.4601	CILINDRETTO PUNTO FISSO	NR	1,000
010.0352	GHIERA AUTOBLOCCANTE 35X1,5	NR	1,000
010.0370	GHIERA 5S 30X1,5	NR	1,000
010.0902	MOLLE PUNTO FISSO TESTA	NR	1,000
010.1201	VITERIA E BULLONERIA	NR	3,000
010.1204	INGRASSATORE M 6	NR	3,000
010.1472	STAFFA AGGANCIO MOLLA	NR	1,000
010.7206	DADO M12	NR	1,000
010.7481	GRANO VCE PUNTA PIANA 8 X 35	NR	1,000
010.7491	GRANO VCE PUNTA PIANA 10 X 60	NR	1,000
010.7605	RONDELLA DIAM. 10	NR	5,000
010.7759	SPINA ELASTICA DIAM. 3 X 16	NR	1,000
010.7767	SPINA ELASTICA DIAM. 6 X 35	NR	2,000
010.7870	VITE TCEI 6 X 16	NR	1,000
010.7891	VITE TCEI 8 X 16	NR	4,000
010.7893	VITE TCEI 8 X 20	NR	10,000
010.7942	VITE TCEI 12 X 40	NR	4,000
010.7975	VITE TE 10 X 25	NR	2,000
010.7987	VITE TE 12 X 40	NR	1,000
016.0486	GUIDA SC.PEZZI SH AX-AXI-CNC "98"	NR	1,000
025.0080	GABBIA ASSIALE A RULLINI AXK 3552	NR	1,000
025.0082	RALLA AS 3552	NR	2,000
025.0239	ANELLO DI TENUTA OR 4112	NR	1,000
025.0452	RULLI 6X6 AISI 420	NR	40,000
034.0399	COPERCHIO SNODO TESTA	NR	1,000
034.1002	LEVA A SCATTO 10 MA	NR	1,000
034.1203	IMPUGNATURA NS. DISEGNO M10	NR	1,000

Cilindergroep

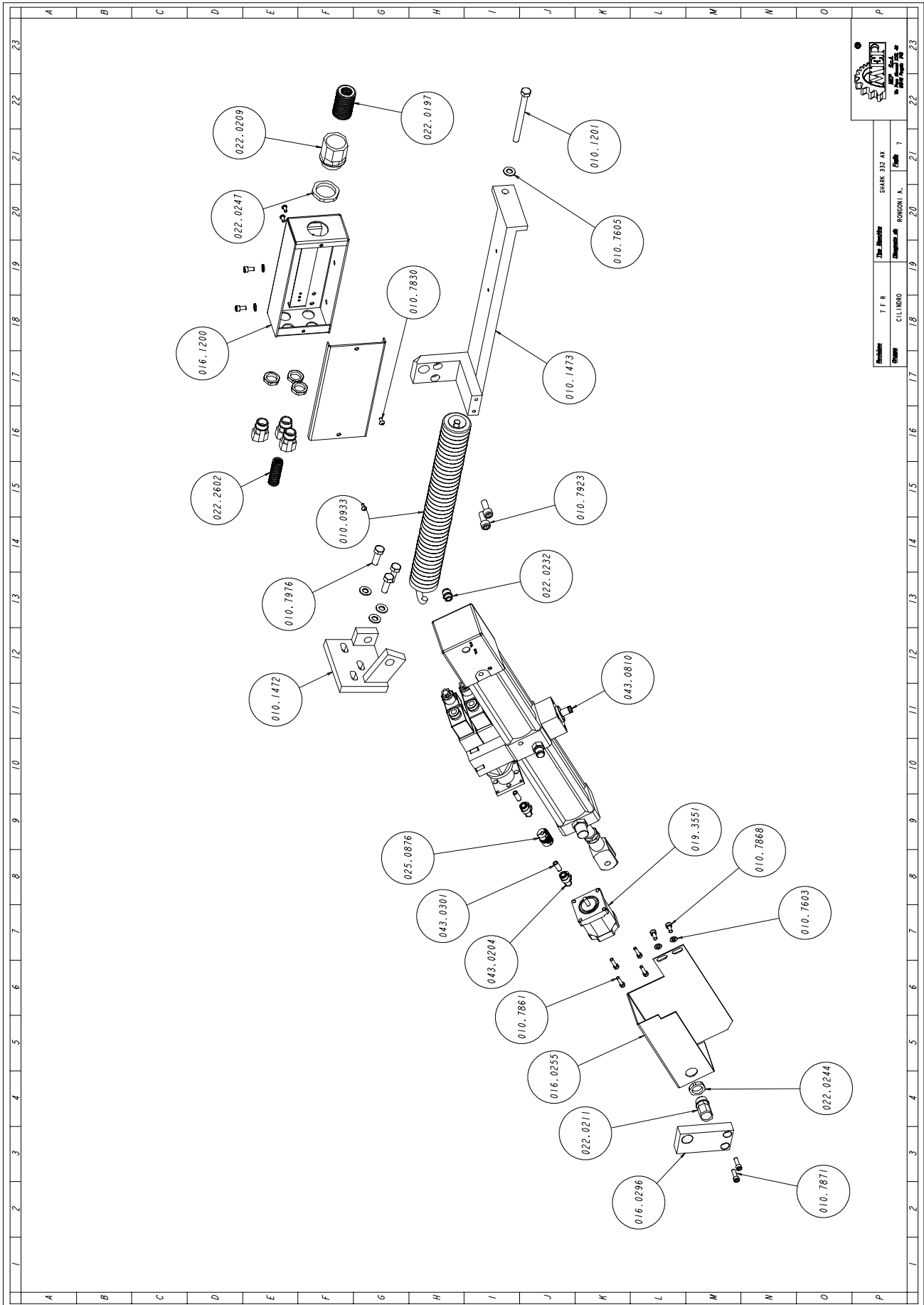

Model	T F R	Zna. Modelle	SHARK 332 AX	Scale	1
Code	CILINDRO	Disegnato da	PONCHI A.	Scale	1

Art. Nr.	Benaming	M.	Hoeveelheid
010.0933	MOLLA RICHIAMO TESTA	NR	1,000
010.1103	FORCELLA 16 X 1,5	NR	1,000
010.1201	VITERIA E BULLONERIA	NR	1,000
010.1473	STAFFA SUPPORTO CILINDRO	NR	1,000
010.7603	RONDELLA DIAM. 6	NR	4,000
010.7605	RONDELLA DIAM. 10	NR	1,000
010.7830	VITE BUTON 5 X 10	NR	4,000
010.7861	VITE TCEI 5 X 20	NR	4,000
010.7868	VITE TCEI 6 X 12	NR	4,000
010.7871	VITE TCEI 6 X 20	NR	2,000
010.7923	VITE TCEI 10 X 25	NR	2,000
016.0255	PROTEZIONE CILINDRO	NR	1,000
016.0296	STAFFA ESTERNA CILINDRO	NR	1,000
016.1200	SCATOLA DI DERIVAZIONE	NR	1,000
019.3551	MOTORE MAE MOD.HY 200 2232 190B8CNC	NR	1,000
022.0046	POTENZIOMETRO 6639S-001-202	NR	1,000
022.0197	GUAINA POLYFLEX NW 29-1200291	MT	1,000
022.0209	RACCORDO RAPIDO SEM 29 ART.3800296	NR	1,000
022.0211	RACCORDO RAPIDO SEM PG 13,5	NR	3,000
022.0232	PRESSACAPO IN OTTONE 1/4 BM 2450	NR	1,000
022.0244	CONTRODADO 3217B GRIGIO PG 13	NR	3,000
022.0247	DADO POLIAM.HUMMEL 1.262.2900.11	NR	1,000
022.0412	CONNETT.BOBINA VALV. RIGENERATRICE	NR	1,000
022.0592	BOBINA VALV. RIGENERATRICE CILINDRO	NR	1,000
022.2602	GUAINA POLIFLEX NW 14-1200143	MT	1,000
025.0876	GIUNTO WA 6-6 MM.28 X CILINDRO	NR	2,000
043.0474	SILENZIATORE IN OTTONE 1/4"	NR	1,000
043.5671	PROTEZIONE POTENZIOMETRO CILINDRO	NR	1,000
043.5681	SUPPORTO POTENZIOMETRO CILINDRO	NR	1,000
043.0810	CILINDRO IDRAULICO	NR	1,000
044.1252	VALVOLA RIGENERATRICE CILINDRO	NR	1,000

Voedingseenheid

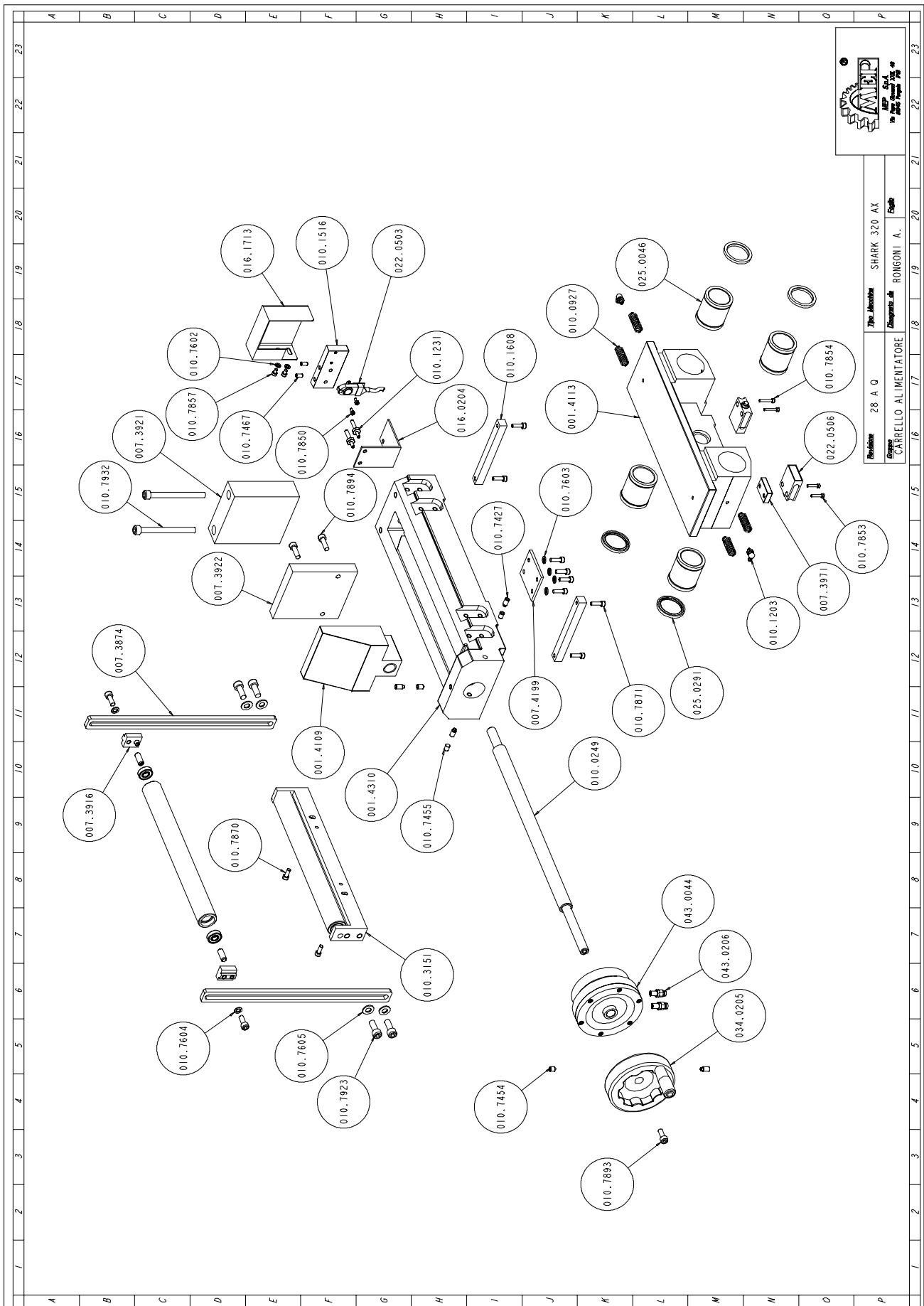

Art. nr.	Benaming	M.	Hoeveelheid
001.4114	CARRELLO-AL-SH320-330-AXI-AXIS.PRT	NR	1
001.4323	MORSA-ALIM-SH330-AXIS.PRT	NR	1
001.4324	CHIOCC-RID-SFR-SH330-AXIS.PRT	NR	1
007.3874	SUPPORTO-RULLO-PREMIBARRA.PRT	NR	2
007.3914	TASSELLO-FIX-RULLO-SH330AXI-S.PRT	NR	2
007.3915	TASSELLO-ANTICADUTA-SH330AXI-S.PRT	NR	2
007.3941	CHIAVETTA-GANASCIA-FISSA.PRT	NR	1
007.3945	PIASTRA-FIX-ALIM-SH330AXI-S.PRT	NR	1
007.3971	DISTAN-FC-ALIM-SH-AX-AXI-S.PRT	NR	1
007.4111	RULLO-SUPPL-20.PRT	NR	1
007.4126	SUPPORTO-RULLO-SUPPL.PRT	NR	2
007.4177	GAN-MOBILE-ALIM-SH330S-AXI.PRT	NR	1
007.4178	GAN-FIX-ALIM-SH330S-AXI.PRT	NR	1
010.0249	VITE-MORSA-ALIM-SH.PRT	NR	1
010.0782	RULLO-ALIM-SH.PRT	NR	2
010.0788	RULLO-COMPLETO-DIA35.ASM	NR	2
010.0927	MOLLA-CARRELLO-ALIM.PRT	NR	4
010.1203	OLIATORE-A-SFERA-DIA6-A-GOMITO.PRT	NR	2
010.1231	VITE-FIX-STAF-FC-ALIM-SH-AUTOM.PRT	NR	2
010.1516	STAFFA-FIX-FC-ALIM-SHAX-I-S-CNC.PRT	NR	1
010.1608	TASSELLO-MORSA-BASCULANTE.PRT	NR	2
010.1660	PERNO-RULLO-ALIM-SHARK.PRT	NR	4
010.3151	SUPPORTO-RULLO-MORSA-ALIM.PRT	NR	1
010.7427	M8X12-VCEI-PR.PRT	NR	4
010.7454	M8X8-VCEI-PC.PRT	NR	1
010.7455	M8X10-VCEI-PC.PRT	NR	3
010.7467	M6X12-VCEI-P.PRT	NR	2
010.7602	ROSETTA-5_3X10.PRT	NR	2
010.7603	ROSETTA-6_4X12_5.PRT	NR	4
010.7604	ROSETTA-8_4X14.PRT	NR	2
010.7605	ROSETTA-10_5X21.PRT	NR	4
010.7774	SPINA-ELASTICA-6X26.PRT	NR	2
010.7850	M4X8-TCEI.PRT	NR	2
010.7853	M4X20-TCEI.PRT	NR	2
010.7854	M4X25-TCEI.PRT	NR	2
010.7857	M5X8-TCEI.PRT	NR	2
010.7859	M5X12-TCEI.PRT	NR	4
010.7870	M6X16-TCEI.PRT	NR	2
010.7871	M6X20-TCEI.PRT	NR	8
010.7893	M8X20-TCEI.PRT	NR	13
010.7894	M8X25-TCEI.PRT	NR	4
010.7923	M10X25-TCEI.PRT	NR	4
010.7932	M10X110-TCEI.PRT	NR	2
016.0204	SUPPORTO-CAT-ALIM-SH.PRT	NR	1
016.1713	PROTEZIONE-FC-ALIM-SHAX-I-S-CNC.PRT	NR	1
022.0503	FINECOR-CROUZET-83-123-018-SHAX.PRT	NR	1
022.0506	FINECORSA-SH200.PRT	NR	2
025.0046	MANICOTTO-DIA-40.PRT	NR	4
025.0060	6000-2Z.PRT	NR	4
025.0203	ANELLO-35X25X7.PRT	NR	2
025.0291	ANELLO-RASCHIAPOLVERE-G400.PRT	NR	4
025.0452	RULLINO-6X6AISI420.PRT	NR	1
034.0205	VOLANTINO-MORSA-125.PRT	NR	1
043.0340	RONDELLA-RAME-1_4.PRT	NR	2
044.0501	NIPPLO-NP-1_4-IDRAULICO.PRT	NR	2
044.1104	VOLAMPRESS-IDR-MEGL.ASM	NR	1
090.5201	ANELLO-OR-128.PRT	NR	1
090.5201	ANELLO-OR-155.PRT	NR	1

Voedingseenheid (vervolg)

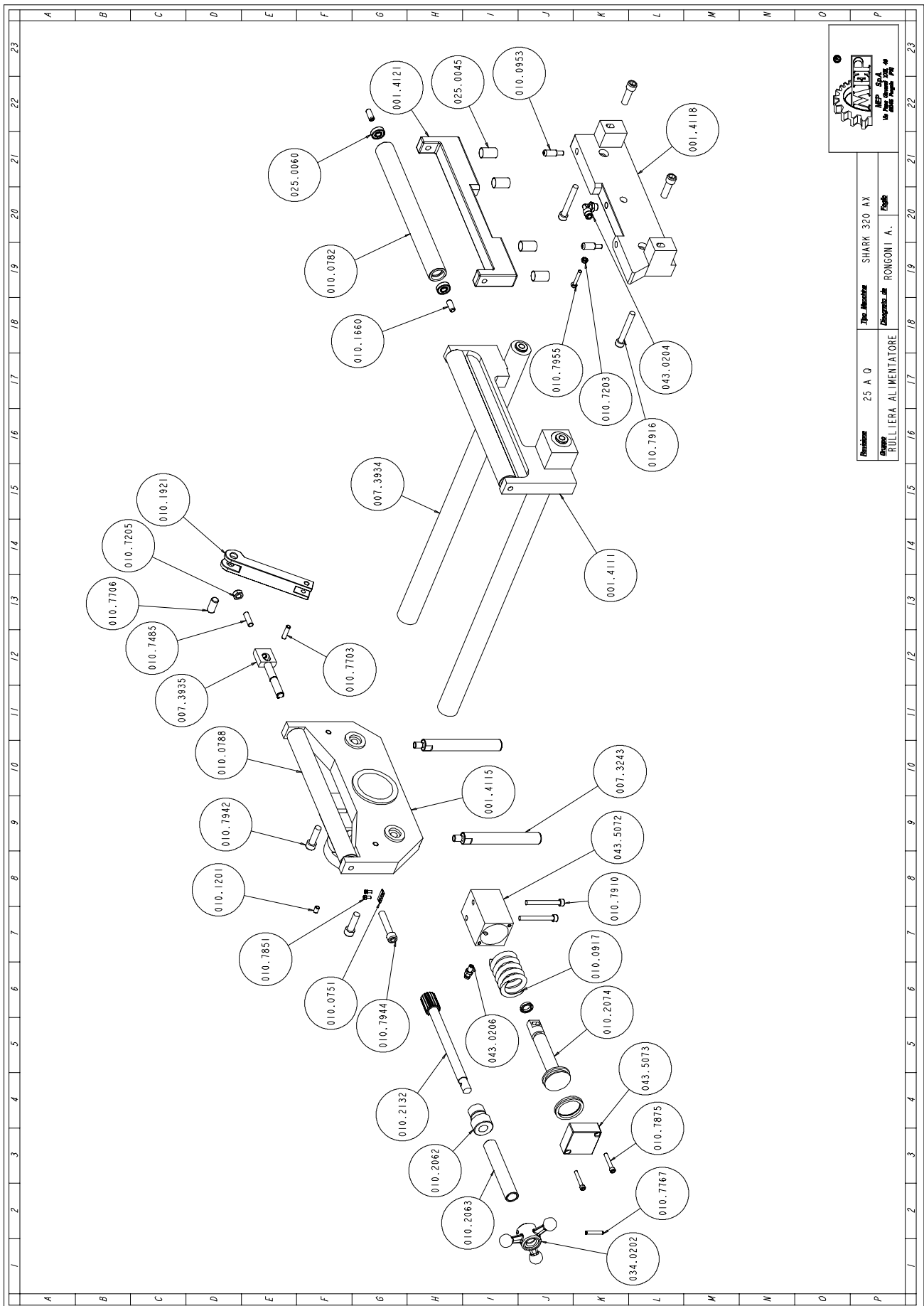

Art. nr.	Benaming	M.	Hoeveelheid
001.4111	SUPPORTO-RS-ALIM-SH320-AX.PRT	NR	1
001.4115	TESTATA-POSTE-ALIM-SH320-AX.PRT	NR	1
001.4322	TESTATA-ALIM-SH330S-AXI.PRT	NR	1
007.3991	GUIDA-CARRELLO-SHARK330AXIS.PRT	NR	2
007.4127	SUPPORTO-ALIMENTATORE-SH330AXIS.PRT	NR	2
010.0751	NONIO-DECIMALE-ALIM.PRT	NR	1
010.0782	RULLO-ALIM-SH.PRT	NR	3
010.0788	RULLO-COMPLETO-DIA35.ASM	NR	3
010.0926	MOLLA-BLOCC-CILINDRO-KG180.PRT	NR	1
010.0951	PERNO-LEVA-SH-AXI-S.PRT	NR	1
010.1201	M12X20-TSPEI.PRT	NR	1
010.1660	PERNO-RULLO-ALIM-SHARK.PRT	NR	6
010.1921	LEVA-BLOCC-CILINDRO-SH-AXI-S.PRT	NR	1
010.2064	BOCCOLA-INGR-REG-CORSA-SH330.PRT	NR	1
010.2065	BOCCOLA-PIGNONE-SH330AXIS.PRT	NR	1
010.2073	PISTONE-CILINDRO-ALIM.ASM	NR	1
010.2073	PISTONE-CILINDRO-ALIM.PRT	NR	1
010.2081	TAPPO-CIL-BLO-CANN-ALIM.PRT	NR	1
010.2133	ALBERO-INGR-REGOLAZIONE-CORSA.PRT	NR	1
010.7203	DADO-M6.PRT	NR	1
010.7205	DADO-M10.PRT	NR	1
010.7206	DADO-M12.PRT	NR	1
010.7210	DADO-M22.PRT	NR	4
010.7485	M10X30-VCEI-P.PRT	NR	1
010.7609	ROSETTA-23X39.PRT	NR	4
010.7703	SPINA-CIL-8X30.PRT	NR	1
010.7706	SPINA-CIL-14X30.PRT	NR	1
010.7830	M5X10-BUTTO.PRT	NR	2
010.7851	M4X10-TCEI.PRT	NR	2
010.7874	M6X35-TCEI.PRT	NR	2
010.7910	M8X70-TCEI.PRT	NR	2
010.7916	M10X75-TCEI.PRT	NR	2
010.7942	M12X40-TCEI.PRT	NR	4
010.7944	M12X60-TCEI.PRT	NR	1
010.7955	M6X35-TE.PRT	NR	1
010.7988	M12X60-TE.PRT	NR	1
016.0440	PROTEZIONE-CAVO-FC-SH330AXIS.PRT	NR	1
025.0060	6000-2Z.PRT	NR	6
025.0232	ANELLO-OR-55_44.PRT	NR	1
025.0236	ANELLO-55X45X7.PRT	NR	1
025.0638	GUARNIZIONE-A-LABBRO-DE106.PRT	NR	1
034.0206	VOLANT-TENS-LAMA.PRT	NR	1
044.0501	NIPPLO-NP-1_4-IDRAULICO.PRT	NR	1
044.1110	CILINDRO-IDRAULICO-55MM-SH.PRT	NR	1

Voedingseenheid (vervolg)

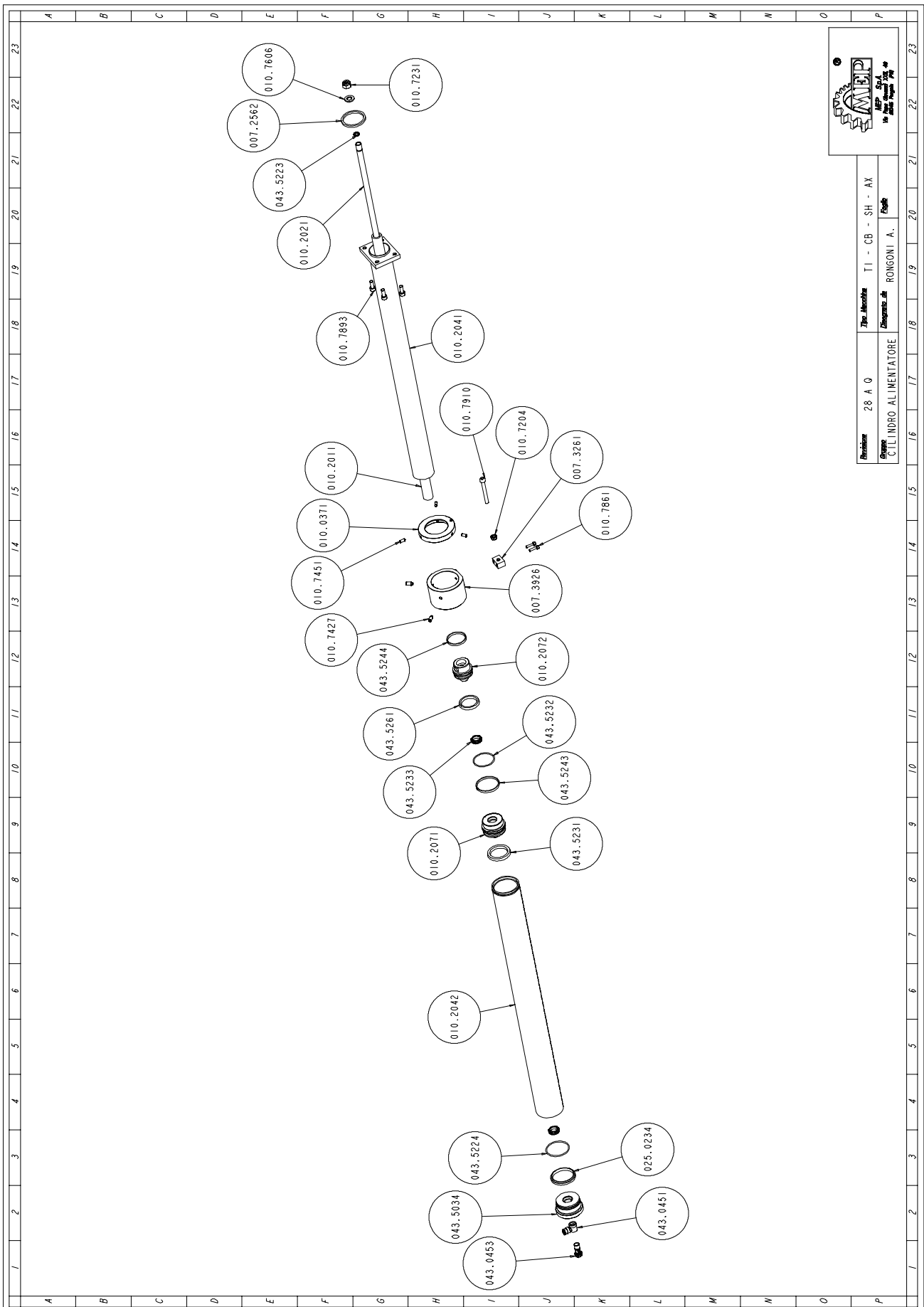

Art. nr.	Benaming	M.	Hoeveelheid
007.3261	TASSELLO-AZIONAMENTO-FC.PRT	NR	1
007.3926	DIST-BAT-CIL_SH_AXI.PRT	NR	1
010.1201	DADO-M20.PRT	NR	4
010.2039	ALBERO-DISTRIBUZIONE-CIL.PRT	NR	1
010.2072	PIST-CIL-ALIM-SH-AX-AXI.ASM	NR	1
010.2072	PISTONE-CILINDRO-50X600-PART1.PRT	NR	1
010.2072	PISTONE-CILINDRO-50X600-PART2.PRT	NR	1
010.7204	DADO-M8.PRT	NR	1
010.7455	M8X10-VCEI-PC.PRT	NR	2
010.7609	ROSETTA-23X39.PRT	NR	2
010.7861	M5X20-TCEI.PRT	NR	2
010.7899	M8X60-TCEI.PRT	NR	1
010.7998	M12X35-TSPEI.PRT	NR	1
025.0635	GUARNIZIONE-A-LABBRO-RS-25_33.PRT	NR	1
025.0636	GUARNIZIONE-RASCHIAPOLVERE-PW25.PRT	NR	1
043.5609	ANELLO-TEN1-CIL-50X600.PRT	NR	2
043.5609	ANELLO-TEN2-CIL-50X600.PRT	NR	2
043.5609	GUAINA-CIL-50X600.PRT	NR	1
044.0501	NIPPLO-NP-1_4-IDRAULICO.PRT	NR	2
044.1151	CORPO-CILINDRO-ALIM-50X600.PRT	NR	1
044.5101	TAPPO-POSTERIORE-ALIM-AX-AXI.PRT	NR	1
044.5102	TAPPO-ANTERIORE-ALIM-AX-AXI.PRT	NR	1
090.5201	ANELLO-OR-150.PRT	NR	2
090.5201	ANELLO-OR-3081.PRT	NR	1