

Explosietekeningen

In het nu volgende deel zijn de explosietekeningen van de machine opgenomen. De tekeningen met hun volledige details kunnen helpen de machine beter te leren kennen.

Motorgroep

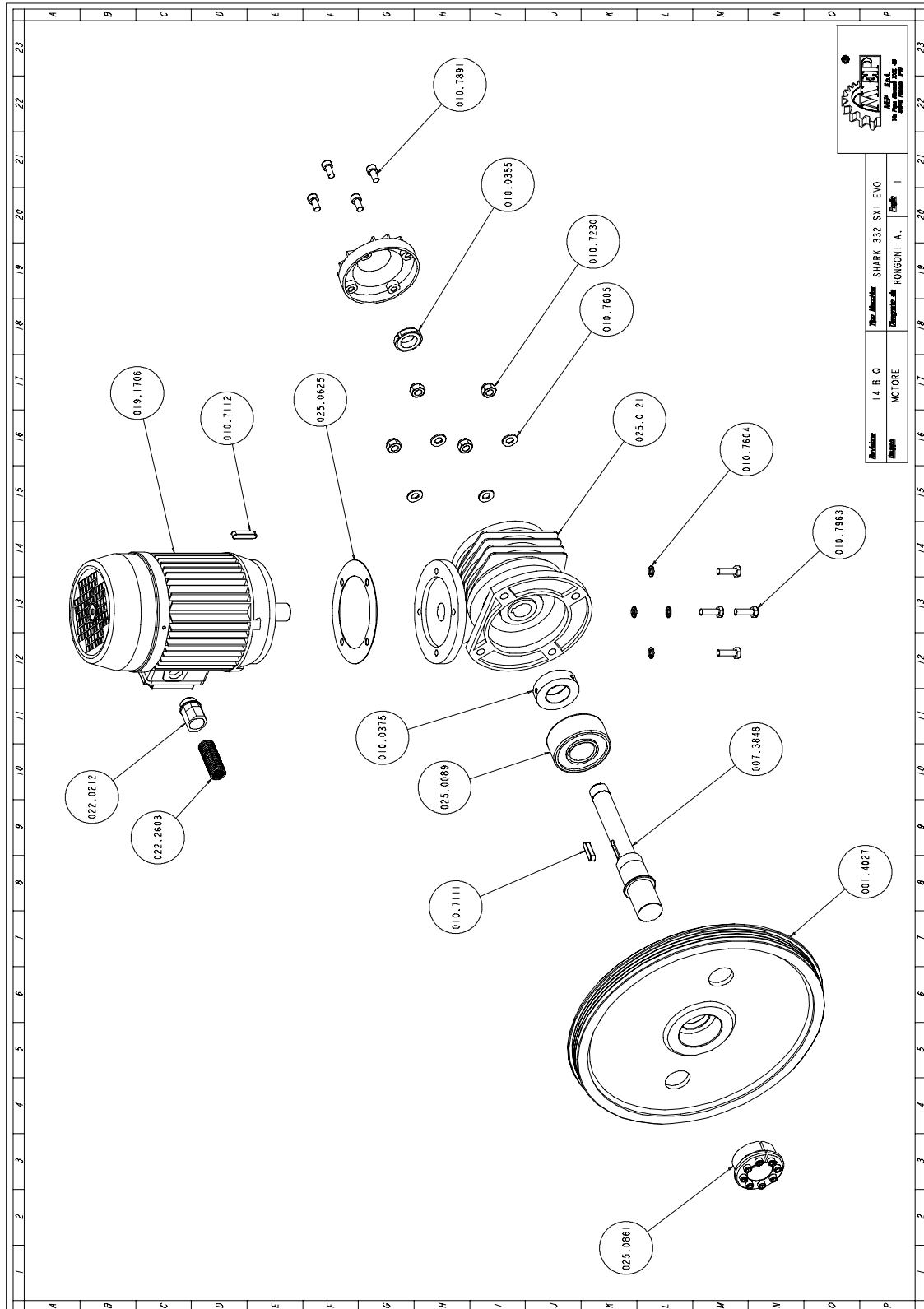

Art. NR.	Benaming	M.	Hoeveelheid
001.4027	PULEGGIA MOTRICE	NR	1,000
007.3848	ALBERO RIDUTTORE CON GHIERA SH	NR	1,000
010.0355	GHIERA AUTOBLOCCANTE 25X1,5	NR	1,000
010.0375	GHIERA X ALBERO RIDUTTORE	NR	1,000
010.7111	CHIAVETTA 8 X 7 X 32	NR	1,000
010.7112	CHIAVETTA 8 X 7 X 35	NR	1,000
010.7230	DADO AUTOBLOCCANTE M10	NR	4,000
010.7604	RONDELLA DIAM. 8	NR	4,000
010.7605	RONDELLA DIAM. 10	NR	4,000
010.7871	VITE TCEI 6 X 20	NR	8,000
010.7891	VITE TCEI 8 X 16	NR	4,000
010.7963	VITE TE 8 X 25	NR	4,000
019.1706	HP 2/2,5 2/4P V.380 B14 FC90L	NR	1,000
022.0212	RACCORDO RAPIDO SEM PG 16	NR	1,000
022.2603	GUAINA POLIFLEX NW 17-1200178	MT	1,000
025.0089	CUSCINETTO 3307 A2RS	NR	1,000
025.0121	RIDUTTORE MVF 63 FCO 1A38 90 B	NR	1,000
025.0625	GUARNIZIONE MOTORE	NR	1,000
025.0861	CALETTATORE 0 35X60	NR	1,000
034.0418	COPERCHIO RIDUTTORE	NR	1,000

Doorsnede loopwiel

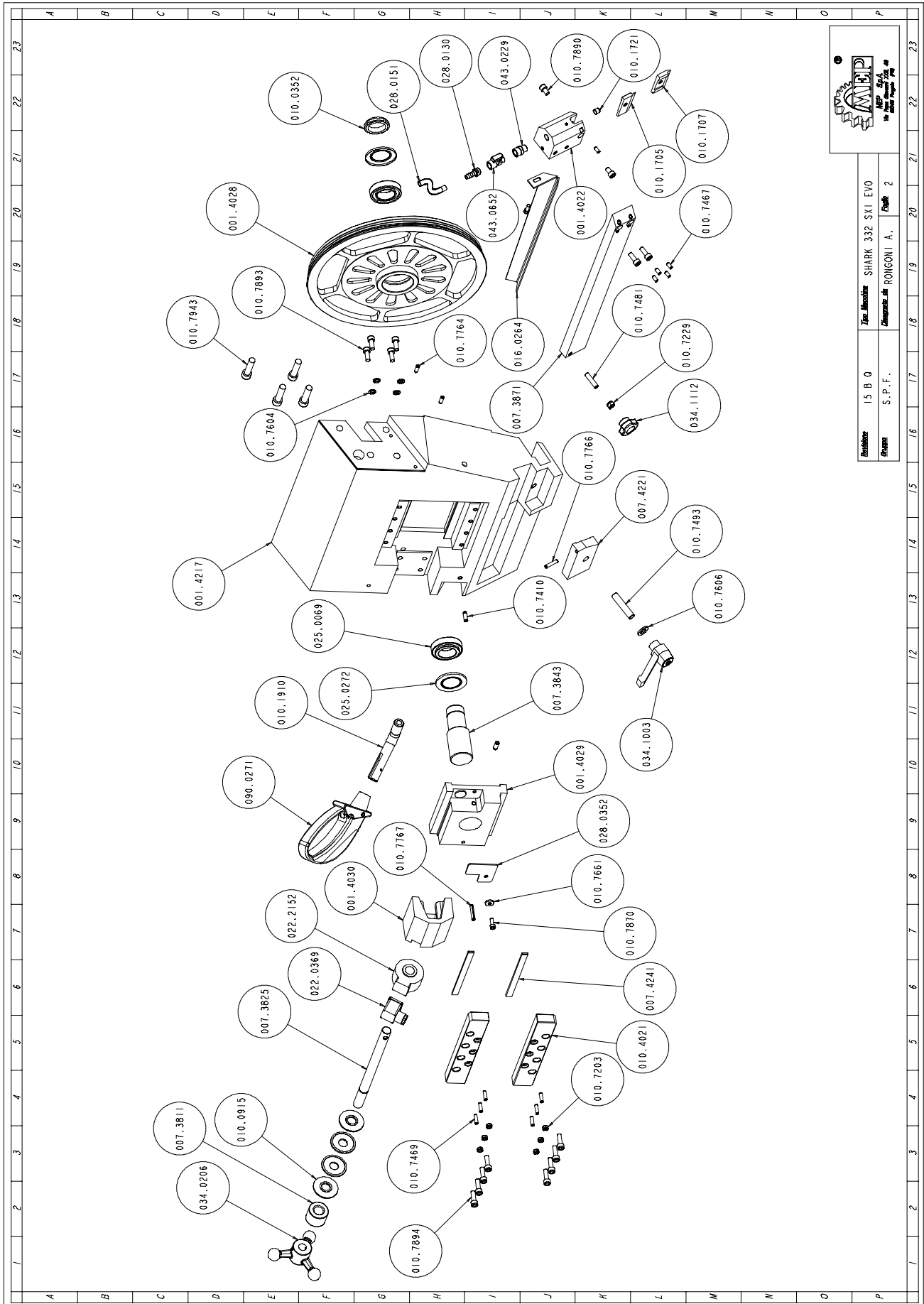

Art. NR.	Benaming	M.	Hoeveelheid
001.4022	TESTINA GUIDALAMA ANTERIORE	NR	1,000
001.4028	PULEGGIA FOLLE ARCHETTO	NR	1,000
001.4029	SLITTA TENDILAMA ARCHETTO	NR	1,000
001.4030	SUPPORTO TENSIONAMENTO LAMA EL	NR	1,000
001.4217	ARCHETTO SEZIONE PULEGGIA FOLL	NR	1,000
007.3811	DISTANZIALE VOLANTINO	NR	1,000
007.3825	PERNO REGISTRO TENSIONAMENTO L	NR	1,000
007.3843	ALBERO VOLANO LIBERO	NR	1,000
007.3871	SUPPORTO TESTINA ANTERIORE	NR	1,000
007.4221	STAFFA BLOCCAGGIO GUIDA TESTIN	NR	1,000
007.4241	LARDONE SLITTA TENDILAMA	NR	2,000
010.0352	GHIERA AUTOBLOCCANTE 35X1,5	NR	1,000
010.0915	MOLLA A TAZZA	NR	4,000
010.1705	GUIDALAMA 1 INSERTO ANTERIORE	NR	1,000
010.1707	GUIDALAMA 2 INSERTI ANTERIORE	NR	1,000
010.1721	PREMILAMA	NR	1,000
010.1910	LEVA COMANDO TESTA BT	NR	1,000
010.4021	PIASTRA REGOLAZIONE SLITTA LAR	NR	2,000
010.7203	DADO M6	NR	6,000
010.7229	DADO AUTOBLOCCANTE M8	NR	1,000
010.7410	GRANO VCE P.CIL. 8 X 16	NR	2,000
010.7467	GRANO VCE PUNTA PIANA 6 X 12	NR	5,000
010.7469	GRANO VCE PUNTA PIANA 6 X 20	NR	6,000
010.7481	GRANO VCE PUNTA PIANA 8 X 35	NR	1,000
010.7493	GRANO VCE PUNTA PIANA 12 X 60	NR	1,000
010.7604	RONDELLA DIAM. 8	NR	4,000
010.7606	RONDELLA DIAM. 12	NR	1,000
010.7661	RONDELLA SPESSORE DIAM. 6 X 3	NR	1,000
010.7764	SPINA ELASTICA DIAM. 6 X 20	NR	2,000
010.7766	SPINA ELASTICA DIAM. 6 X 30	NR	1,000
010.7767	SPINA ELASTICA DIAM. 6 X 35	NR	1,000
010.7870	VITE TCEI 6 X 16	NR	2,000
010.7890	VITE TCEI 8 X 12	NR	2,000
010.7893	VITE TCEI 8 X 20	NR	6,000
010.7894	VITE TCEI 8 X 25	NR	8,000
010.7943	VITE TCEI 12 X 45	NR	4,000
016.0264	PROTEZIONE LAMA ANTERIORE	NR	1,000
022.0369	CONNETTORE PER BOBINA U2	NR	1,000
022.2152	TENSIONATORE ELETTRONICO 02	NR	1,000
025.0069	CUSCINETTO 32007X	NR	2,000
025.0272	ANELLO DI PROTEZIONE NILOS 320	NR	2,000
028.0130	RACCORDO 1/4-9 CL 2601	NR	1,000
028.0151	TUBO PLASTIFICATO 07-11	MT	1,000
028.0352	PROTEZIONE GOMMA SLITTA TENDIL	NR	1,000
034.0206	VOLANTINO TENSIONAMENTO LAMA	NR	1,000
034.1003	LEVA A SCATTO 12 MA	NR	1,000
034.1112	VOLANTINO DIAM.40 M8	NR	1,000
043.0229	RIDUZIONE MF 1/4 - CL 2520	NR	1,000
043.0652	RUBINETTO 1/4 F.M.	NR	1,000
090.0271	IMPUGNATURA COMPLETA TIPO MEP	NR	1,000

Doorsnede aandrijfwiël

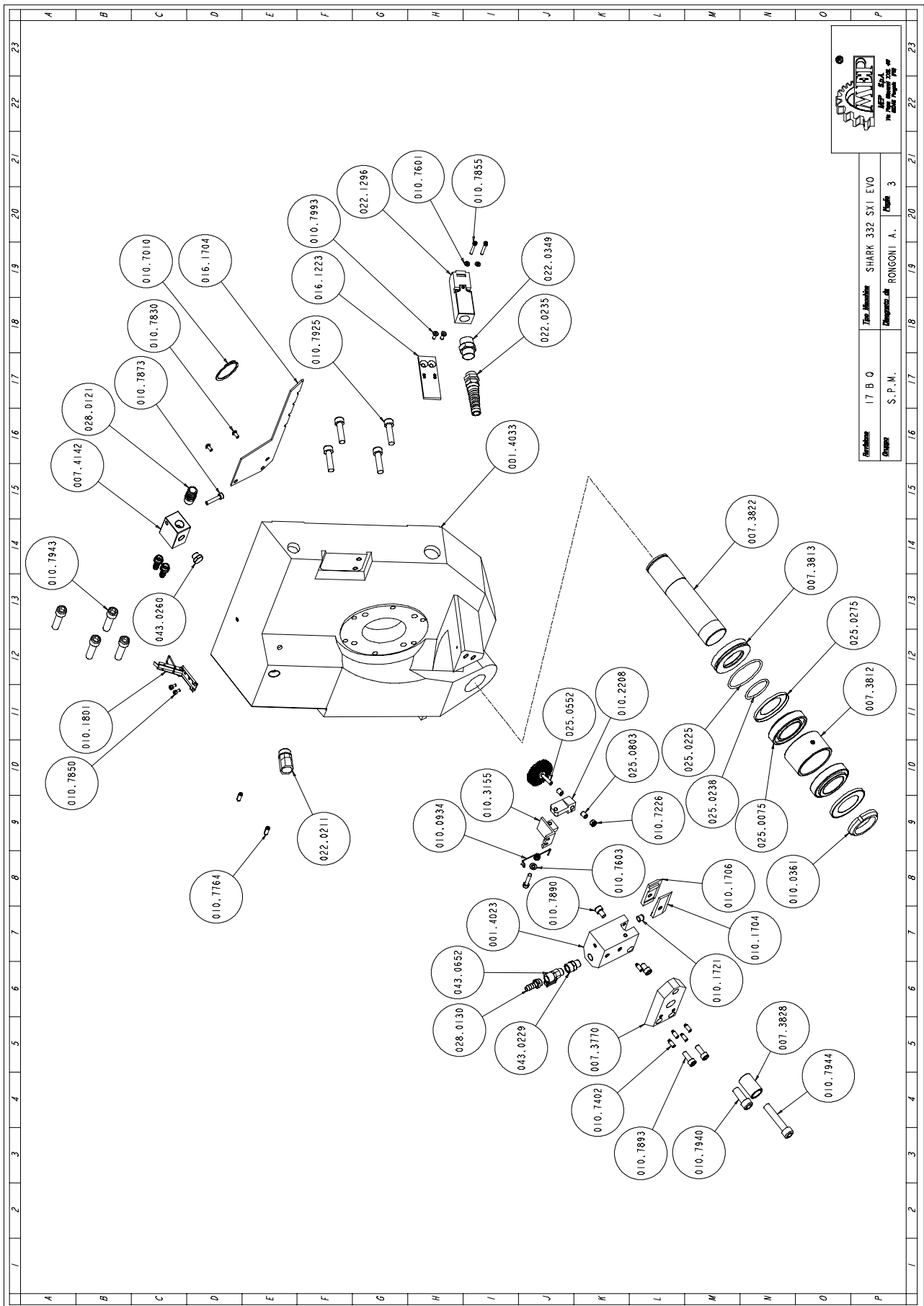

Art. NR.	Benaming	M.	Hoeveelheid
001.4023	TESTINA GUIDALAMA POSTERIORE	NR	1,000
001.4033	ARCHETTO SEZ.PULEGGIA MOTRICE	NR	1,000
007.3770	SUPPORTO TESTINA POSTERIORE	NR	1,000
007.3812	DISTANZIALE CUSCINETTO SNODO T	NR	1,000
007.3813	DISTANZIALE ARCHETTO	NR	1,000
007.3822	PERNO SUPPORTO SNODO TESTA	NR	1,000
007.3828	BOCCOLA BATTUTA FINE CORSA	NR	1,000
007.4142	SQUADRETTO PER LIQUIDO	NR	1,000
010.0361	GHIERA DI PRECISIONE 45X1,5	NR	1,000
010.0934	MOLLA X PULILAMA	NR	1,000
010.1704	GUIDALAMA 1 INSERTO POSTERIORE	NR	1,000
010.1706	GUIDALAMA 2 INSERTI POSTERIORE	NR	1,000
010.1721	PREMILAMA	NR	1,000
010.1801	CHIUSURA LEVA "D" ZINCATA	NR	1,000
010.2208	PORTASPAZZOLA PULILAMA	NR	1,000
010.3155	.STAFFA FIX SPAZZOLA PULILAMA	NR	1,000
010.7010	ANELLO SEEGER DIAM. 45 US.010.	NR	1,000
010.7226	DADO AUTOBLOCCANTE M6	NR	1,000
010.7402	GRANO VCE P.CIL. 6 X 12	NR	5,000
010.7601	RONDELLA DIAM. 4	NR	2,000
010.7603	RONDELLA DIAM. 6	NR	1,000
010.7764	SPINA ELASTICA DIAM. 6 X 20	NR	2,000
010.7830	VITE BUTON 5 X 10	NR	2,000
010.7850	VITE TCEI 4 X 8	NR	2,000
010.7855	VITE TCEI 4 X 30	NR	2,000
010.7873	VITE TCEI 6 X 30	NR	2,000
010.7890	VITE TCEI 8 X 12	NR	2,000
010.7893	VITE TCEI 8 X 20	NR	2,000
010.7925	VITE TCEI 10 X 40	NR	4,000
010.7940	VITE TCEI 12 X 30	NR	1,000
010.7943	VITE TCEI 12 X 45	NR	4,000
010.7944	VITE TCEI 12 X 60	NR	1,000
010.7993	VITE TSPEI 5 X 12	NR	2,000
016.1223	PIASTR.FIX INTERR.SICUR.ARCHET	NR	1,000
016.1704	PROTEZIONE LAMA POSTERIORE SH	NR	1,000
022.0211	RACCORDO RAPIDO SEM PG 13,5	NR	1,000
022.0235	PRESSACORDONE 3243 NERO PG 11	NR	1,000
022.0349	ADATTATORE M20-FEMM.PG 13,5 X	NR	1,000
022.1296	INTERRUTTORE DI SICUREZZA RS21	NR	1,000
025.0075	CUSCINETTO 32009X	NR	2,000
025.0225	ANELLO TENUTA OR 171-68,26	NR	1,000
025.0238	ANELLO DI TENUTA OR 44.45X3,53	NR	1,000
025.0275	ANELLO DI PROTEZIONE NILOS 320	NR	2,000
025.0552	SPAZZOLA PULILAMA 6X25 030 GG5	NR	1,000
025.0803	BOCCOLA GRAFITATA L. 10 DIAM.	NR	2,000
028.0121	RACCORDO 3/8-17 CL 2601	NR	1,000
028.0130	RACCORDO 1/4-9 CL 2601	NR	3,000
043.0229	RIDUZIONE MF 1/4 - CL 2520	NR	1,000
043.0260	TAPPO TTE4 1/4 - CL 2611	NR	1,000
043.0652	RUBINETTO 1/4 F.M.	NR	1,000

Afdekking zaagbeugel

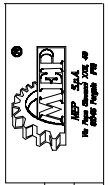
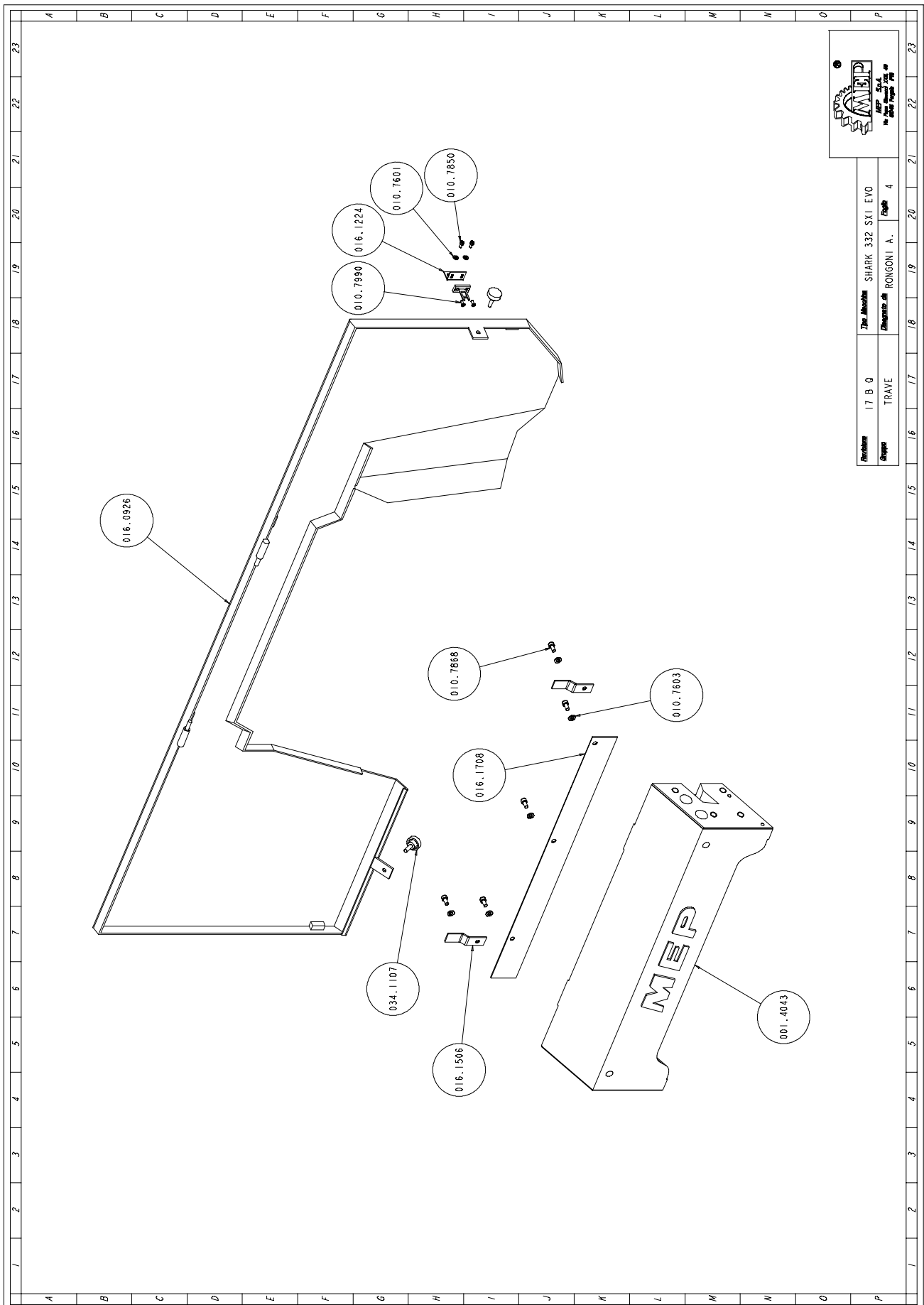

Reference	17 B Q	The Machine	SHARK 332 SXI EVO
Group	TRAVE	Disegnato da	RONGONI A.
		Figura	4

Art. NR.	Benaming	M.	Hoeveelheid
001.4043	TRAVE ARCHETTO SH 332	NR	1,000
010.7601	RONDELLA DIAM. 4	NR	2,000
010.7603	RONDELLA DIAM. 6	NR	5,000
010.7850	VITE TCEI 4 X 8	NR	2,000
010.7868	VITE TCEI 6 X 12	NR	5,000
010.7990	VITE TSPEI 4 X 8	NR	2,000
016.0926	COPERCHIO ARCHETTO SH 332	NR	1,000
016.1224	PIASTR.FIX INTER.SICUR.COPERCH	NR	1,000
016.1506	STAFFA DI FERMO	NR	2,000
016.1708	PROTEZIONE CAVI SH 330 CNCFE 6	NR	1,000
034.1107	VOLANTINO DIAM.30 M6 X 20	NR	2,000

Klemgroep

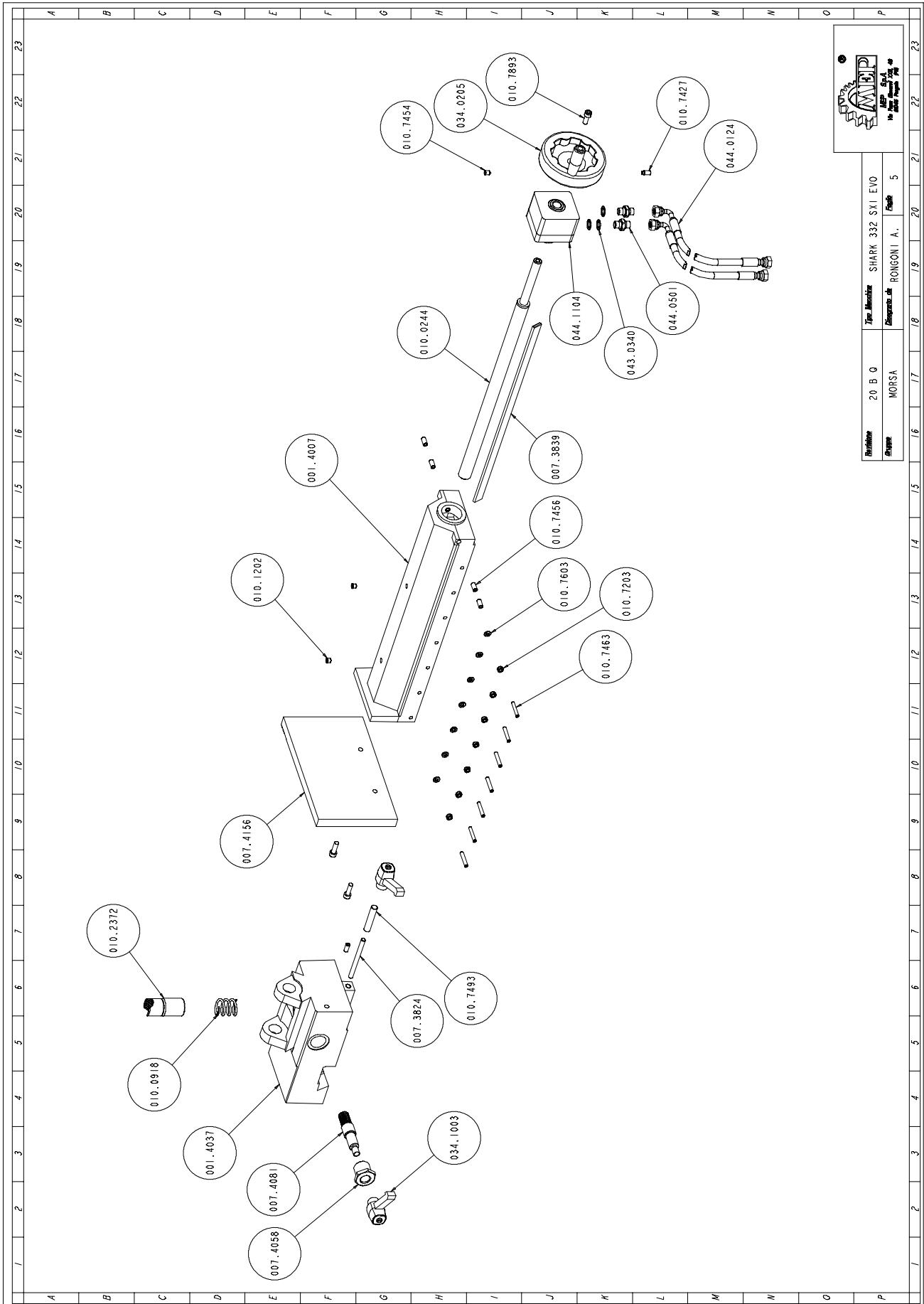

		Part Number	SHARK 332 SXI EVO
		Type / Modelling	SHARK 332 SXI EVO
Part Name	MORSA	Manufacturer	RONGONI A. S.p.A.
Quantity	5	Revision	5

Art. NR.	Benaming	M.	Hoeveelheid
001.4007	SCORREVOLE MORSA	NR	1,000
001.4037	SUPPORTO MORSA	NR	1,000
007.3824	PERNO BLOCCAGGIO MORSA MSR	NR	1,000
007.3839	LARDONE MORSA	NR	1,000
007.4058	BOCCOLA ECCENTRICA	NR	1,000
007.4081	PIGNONE SBLOCCAGGIO SCORREVOLE	NR	1,000
007.4156	GANASCIA MORSA MOBILE SH 332	NR	1,000
010.0244	VITE MORSA	NR	1,000
010.0918	MOLLA RICHIAMO CHIOCC.VITE MOR	NR	1,000
010.1202	OLIATORE A SFERA DIAM. 8	NR	2,000
010.2372	CHIOCCIOLA BRONZO 45° SH 332	NR	1,000
010.7203	DADO M6	NR	7,000
010.7427	GRANO VCE P.CIL. 8 X 12	NR	1,000
010.7454	GRANO VCE P.CON. 8 X 8	NR	1,000
010.7456	GRANO VCE P.CON. 8 X 16	NR	5,000
010.7463	GRANO VCE P.CON. 6 X 35	NR	7,000
010.7493	GRANO VCE PUNTA PIANA 12 X 60	NR	1,000
010.7603	RONDELLA DIAM. 6	NR	7,000
010.7859	VITE TCEI 5 X 12	NR	4,000
010.7893	VITE TCEI 8 X 20	NR	1,000
010.7894	VITE TCEI 8 X 25	NR	6,000
025.0203	ANELLO TENUTA 35X25X7	NR	2,000
025.0217	ANELLO TENUTA OR 155-50,80	NR	1,000
025.0452	RULLI 6X6 AISI 420	NR	1,000
034.0205	VOLANTINO VPRA/125 MR	NR	1,000
034.1003	LEVA A SCATTO 12 MA	NR	2,000
043.0340	RONDELLA RAME 13X19X1,5- 1/4	NR	3,000
044.0124	TUBO CENTRALINA IDRAULICA MM.7	NR	2,000
044.0501	NIPPLO NP 1/4 IDRAULICO	NR	2,000
044.1104	CILINDRO VOLAMPRESS	NR	1,000

Groep vaste tafel

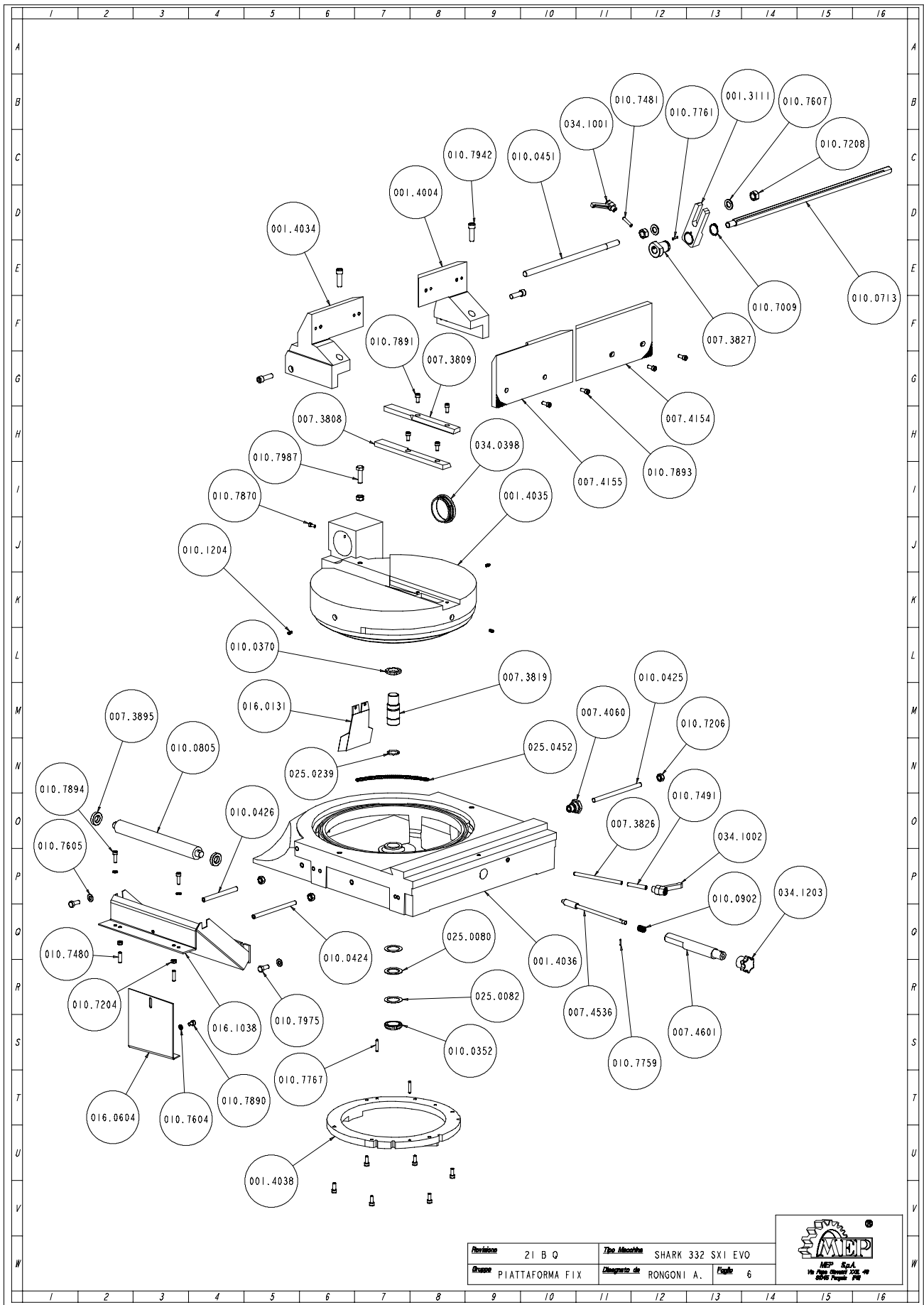

Revisione	21 B Q	Tipi Macchine	SHARK 332 SXI EVO
Gruppo	PIATTAFORMA FIX	Disegnato da	RONGONI A. Foglio 6



Art. NR.	Benaming	M.	Hoeveelheid
001.3111	DISTANZIALE BATTUTA	NR	1,000
001.4004	SQUADRO MORSA DESTRO	NR	1,000
001.4034	SQUADRO MORSA SX	NR	1,000
001.4035	PIANO GIREVOLE SH	NR	1,000
001.4036	PIATTAFORMA FISSA	NR	1,000
001.4038	ANELLO PIANO GIREVOLE 60°	NR	1,000
007.3808	PIASTRA APPOGGIA PEZZI SINISTR	NR	1,000
007.3809	PIASTRA APPOGGIA PEZZI DESTRA	NR	1,000
007.3819	PERNO DI CENTRO	NR	1,000
007.3826	PERNO BLOCC.PIANO GIREVOLE	NR	1,000
007.3827	BOCCOLA PER BATTUTA	NR	1,000
007.3895	BOCCOLA Ø 38 X RULLO	NR	2,000
007.4060	BOCCOLA BATTUTA 45° DX SH 320	NR	1,000
007.4154	GANASCIA MORSA DESTRA SH 332	NR	1,000
007.4155	GANASCIA MORSA SINISTRA SH 332	NR	1,000
007.4536	PERNO PUNTO FISSO	NR	1,000
007.4601	CILINDRETTO PUNTO FISSO	NR	1,000
010.0352	GHIERA AUTOBLOCCANTE 35X1,5	NR	1,000
010.0370	GHIERA 5S 30X1,5	NR	1,000
010.0424	GRANO PUNTA PIANA 12X170	NR	1,000
010.0425	GRANO PUNTA PIANA 12X190	NR	1,000
010.0426	GRANO PUNTA PIANA 12X135	NR	1,000
010.0451	TIRANTE BATTUTA TAGLI MISURA	NR	1,000
010.0713	ASTA MILLIM.MM.600 Ø 20 FIL.M1	NR	1,000
010.0805	RULLO CARBONITRURATO	NR	1,000
010.0902	MOLLE PUNTO FISSO TESTA	NR	1,000
010.1204	INGRASSATORE M 6	NR	3,000
010.7009	ANELLO SEEGER DIAM. 30	NR	1,000
010.7204	DADO M8	NR	2,000
010.7206	DADO M12	NR	4,000
010.7208	DADO M16	NR	2,000
010.7480	GRANO VCE PUNTA PIANA 8 X 30	NR	2,000
010.7481	GRANO VCE PUNTA PIANA 8 X 35	NR	2,000
010.7491	GRANO VCE PUNTA PIANA 10 X 60	NR	1,000
010.7604	RONDELLA DIAM. 8	NR	3,000
010.7605	RONDELLA DIAM. 10	NR	2,000
010.7607	RONDELLA DIAM. 16	NR	2,000
010.7759	SPINA ELASTICA DIAM. 3 X 16	NR	1,000
010.7761	SPINA ELASTICA DIAM. 4 X 20	NR	1,000
010.7767	SPINA ELASTICA DIAM. 6 X 35	NR	2,000
010.7870	VITE TCEI 6 X 16	NR	1,000
010.7890	VITE TCEI 8 X 12	NR	1,000
010.7891	VITE TCEI 8 X 16	NR	4,000
010.7893	VITE TCEI 8 X 20	NR	10,000
010.7894	VITE TCEI 8 X 25	NR	2,000
010.7942	VITE TCEI 12 X 40	NR	4,000
010.7975	VITE TE 10 X 25	NR	2,000
010.7987	VITE TE 12 X 40	NR	1,000
016.0131	CARTER TRUCIOLI PER PIANO GIRE	NR	1,000
016.0604	SUPP.BRACCETTO APPOGGIA BARRA	NR	1,000
016.1038	BRACCETTO APPOGGIA BARRA SH 28	NR	1,000
025.0080	GABBIA ASSIALE A RULLINI AXK 3	NR	1,000
025.0082	RALLA AS 3552	NR	2,000
025.0239	ANELLO DI TENUTA OR 4112	NR	1,000
025.0452	RULLI 6X6 AISI 420	NR	40,000
034.0398	COPERCHIO SNODO TESTA SH N.T.	NR	1,000
034.1001	LEVA A SCATTO 8 MA PK55	NR	1,000
034.1002	LEVA A SCATTO 10 MA	NR	1,000
034.1203	IMPUGNATURA NS. DISEGNO M10	NR	1,000

Onderstel

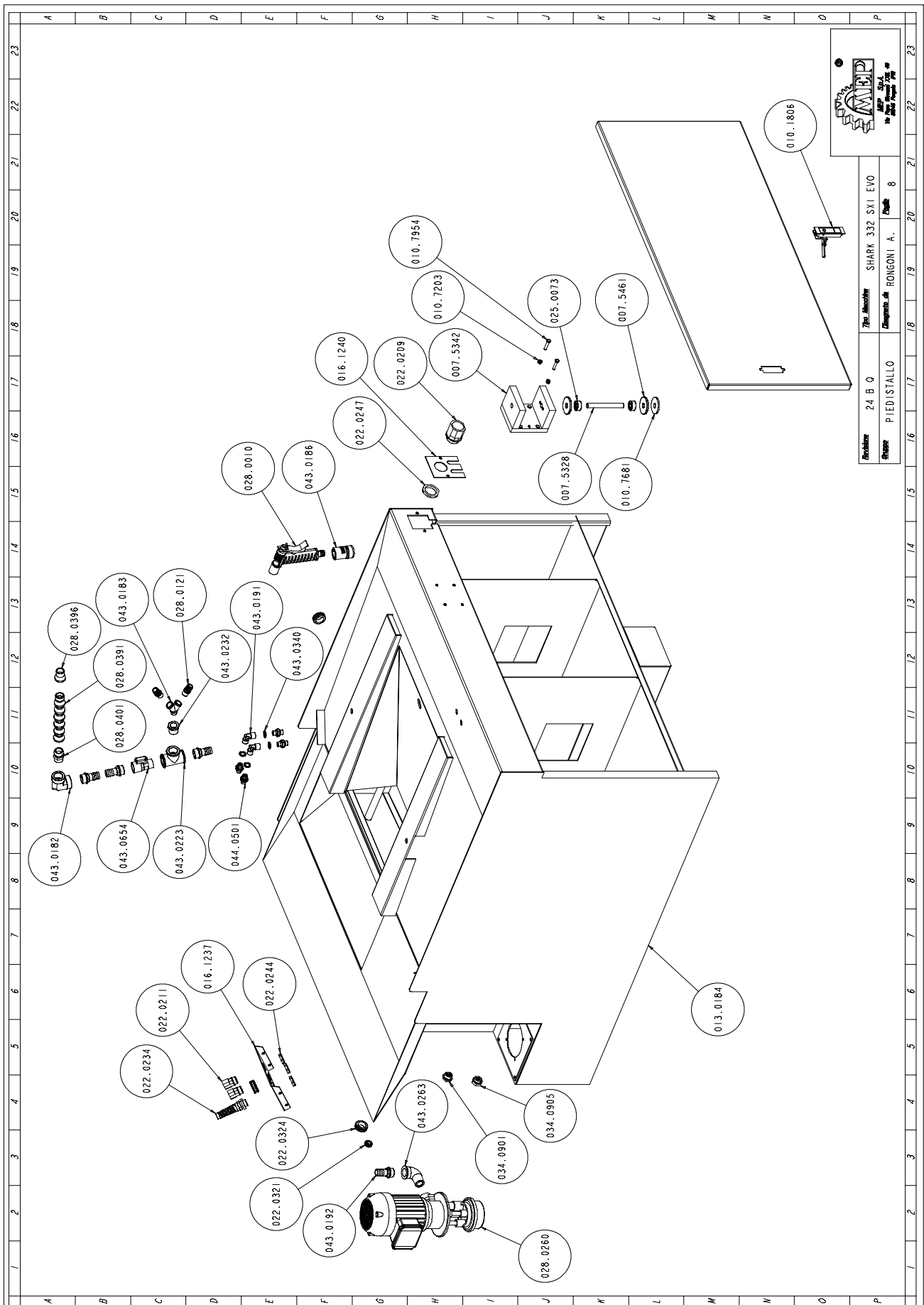

Art. NR.	Benaming	M.	Hoeveelheid
007.5328	PERNO PER CUSCINETTO ASTA MOBI	NR	1,000
007.5342	SUPPORTO ASTA MOBILE SH 420 SE	NR	1,000
007.5461	ROSETTA ASTA MOBILE SH 420 SE	NR	2,000
010.1806	CHIUSURA SPORTELLO PIEDISTALLO	NR	1,000
010.7203	DADO M6	NR	2,000
010.7681	ROSETTA SPESSORE 12 X 48	NR	1,000
010.7954	VITE TE 6 X 30	NR	2,000
013.0184	PIEDISTALLO SH 332 CCS - SXI	NR	1,000
016.1237	PIASTRA PASSACAVI POSTERIORE S	NR	1,000
016.1240	PIASTRA PASSACAVI ANTERIORE SH	NR	1,000
022.0209	RACCORDO RAPIDO SEM 29 ART.380	NR	1,000
022.0211	RACCORDO RAPIDO SEM PG 13,5	NR	2,000
022.0234	PRESSACORDONE 3246 NERO PG 13,	NR	1,000
022.0244	CONTRODADO 3217B GRIGIO PG 13	NR	3,000
022.0247	DADO POLIAM.HUMMEL 1.262.2900.	NR	1,000
022.0321	PASSACAVI 12 INC.MM.2	NR	1,000
022.0324	PASSACAVI 24 INC.MM.2.5	NR	3,000
025.0073	CUSCINETTO 63001 2RS	NR	2,000
028.0010	PISTOLA	NR	1,000
028.0121	RACCORDO 3/8-17 CL 2601	NR	2,000
028.0260	ELETTROPOMPA	NR	1,000
028.0391	TUBO LOOC LINE SPD FP50.10315	MT	1,000
028.0396	UGELLO Ø 20 SPD FP50.11B50	NR	1,000
028.0401	RACCORDO 3/4 SPD FP50.17A20	NR	1,000
034.0901	TAPPO LIVELLO OLIO 1/2" GAS.	NR	1,000
034.0905	TAPPO OLIO TAO/3 1/2" NERO	NR	1,000
043.0182	RACCORDO A GOMITO FF ZINCATO 3	NR	1,000
043.0183	RACCORDO A Y 90° MASCHIO 3/8	NR	1,000
043.0186	RACCORDO FEMMINA 1/2 AQUASTOP	NR	1,000
043.0191	RACCORDO A GOMITO CL 2013 FF 1	NR	2,000
043.0192	RACCORDO RB 9889 3/4X20	NR	4,000
043.0223	RACCORDO TE FFF ZINCATO 3/4	NR	1,000
043.0232	RIDUZIONE ZINCATA 3/4	NR	1,000
043.0263	RACCORDO A GOMITO M/F ZINCATO	NR	1,000
043.0340	RONDELLA RAME 13X19X1,5- 1/4	NR	4,000
043.0654	RUBINETTO M/F 3/4 CL 6310	NR	1,000
044.0501	NIPPLO NP 1/4 IDRAULICO	NR	4,000

Cilindergroep

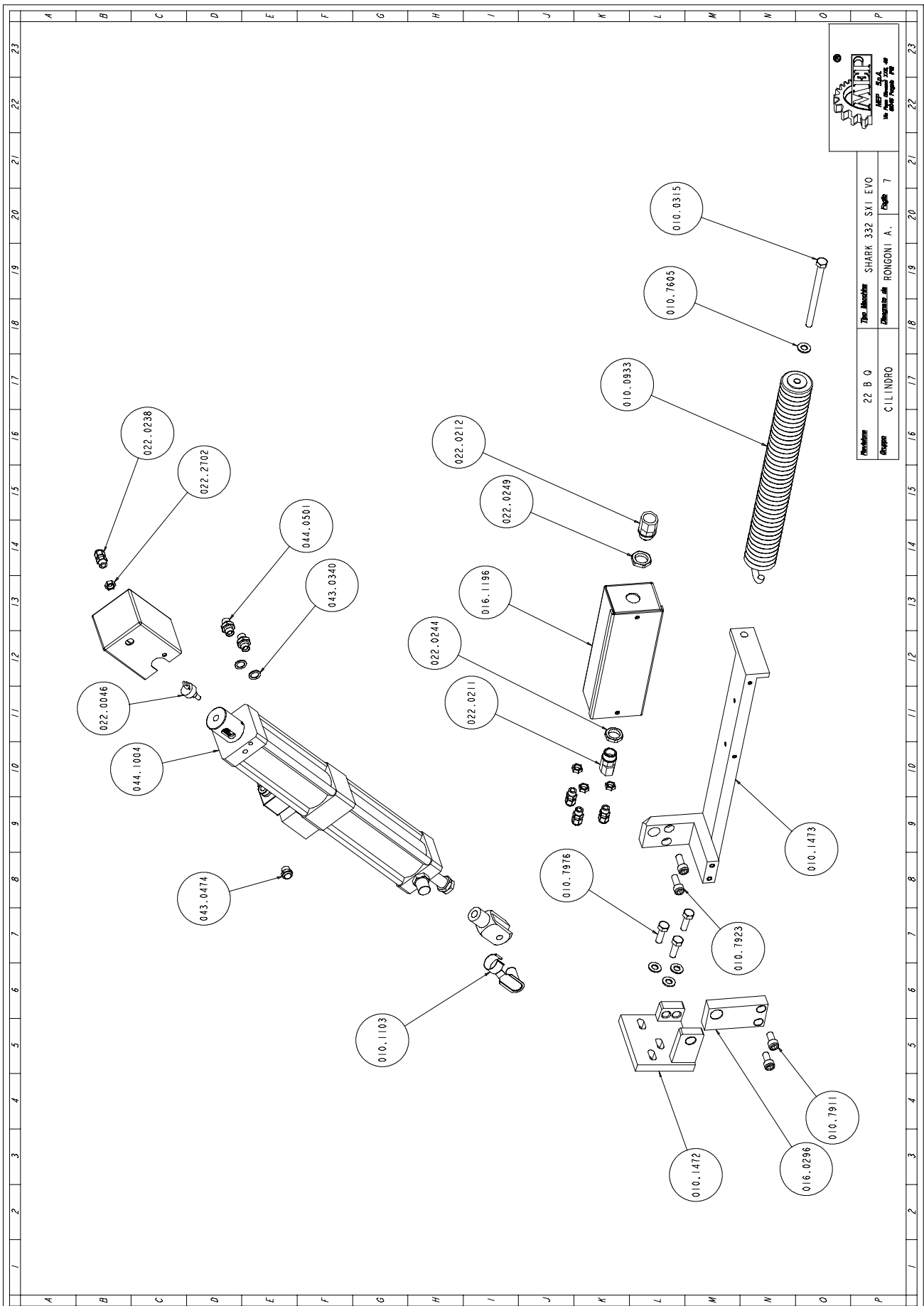

Art. NR.	Benaming	M.	Hoeveelheid
010.0315	VITE 8.8 T.E. 10X140	NR	1,000
010.0933	MOLLA RICHIAMO TESTA	NR	1,000
010.1103	FORCELLA 16 X 1,5	NR	1,000
010.1472	STAFFA AGGANCIAMENTO MOLLA	NR	1,000
010.1473	STAFFA SUPPORTO CILINDRO	NR	1,000
010.7605	RONDELLA DIAM. 10	NR	4,000
010.7911	VITE TCEI 10 X 20	NR	2,000
010.7923	VITE TCEI 10 X 25	NR	2,000
010.7976	VITE TE 10 X 30	NR	3,000
016.0296	STAFFA ESTERNA CILINDRO	NR	1,000
016.1196	SCATOLA DI DERIVAZIONE SH SXI	NR	1,000
022.0046	POTENZIOMETRO 6639S-001-202	NR	1,000
022.0211	RACCORDO RAPIDO SEM PG 13,5	NR	1,000
022.0212	RACCORDO RAPIDO SEM PG 16	NR	1,000
022.0238	PRESSACAVO PG 7 BS01	NR	4,000
022.0244	CONTRODADO 3217B GRIGIO PG 13	NR	1,000
022.0249	DADO POLIAM.HUMMEL 1.262.1600.	NR	1,000
022.2702	DADO PG 7 BL01	NR	4,000
043.0340	RONDELLA RAME 13X19X1,5-1/4	NR	2,000
043.0474	SILENZIATORE IN OTTONE 1/4"	NR	1,000
044.0501	NIPPLO NP 1/4 IDRAULICO	NR	2,000
044.1004	.	NR	1,000

Bedieningspaneel

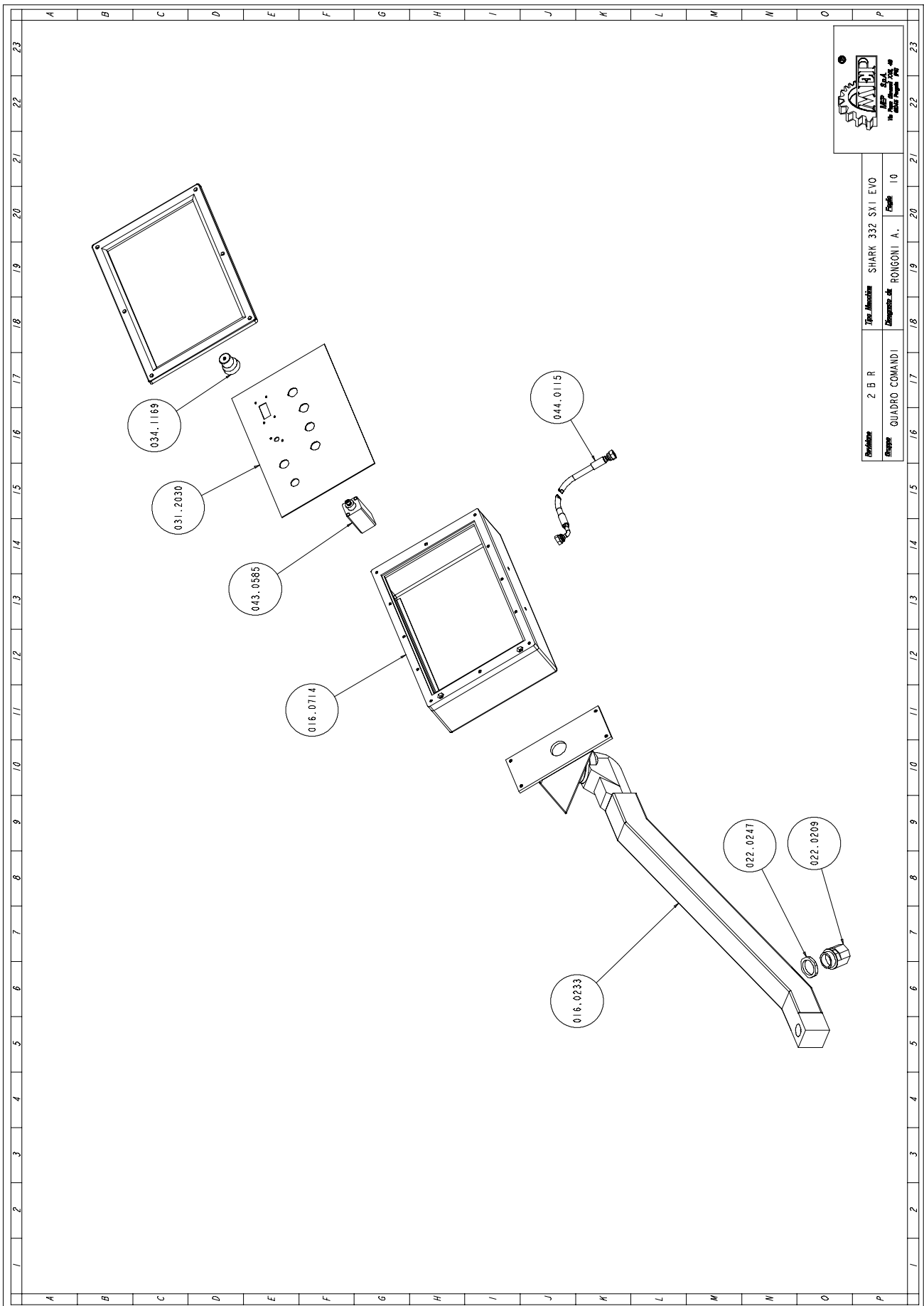

Art. NR.	Benaming	M.	Hoeveelheid
016.0233	ASTA MOBILE X CONSOLLE COMPLET	NR	1,000
016.0714	QUADRO COMANDI SH SXI N.T.	NR	1,000
022.0209	RACCORDO RAPIDO SEM 29 ART.380	NR	1,000
022.0247	DADO POLIAM.HUMMEL 1.262.2900.	NR	1,000
025.0604	GUARNIZIONE QUADRO COMANDI	MT	1,500
031.2030	CONSOLLE DI PROGRAMMAZIONE	NR	1,000
034.1169	MANOPOLA REGOLAZIONE MONOGIRO	NR	1,000
043.0585	REGOLATORE DISCESA TESTA CON V	NR	1,000
044.0115	TUBO CENTRALINA IDRAULICA MM.5	NR	1,000

Hydraulische aggregaten

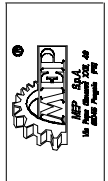
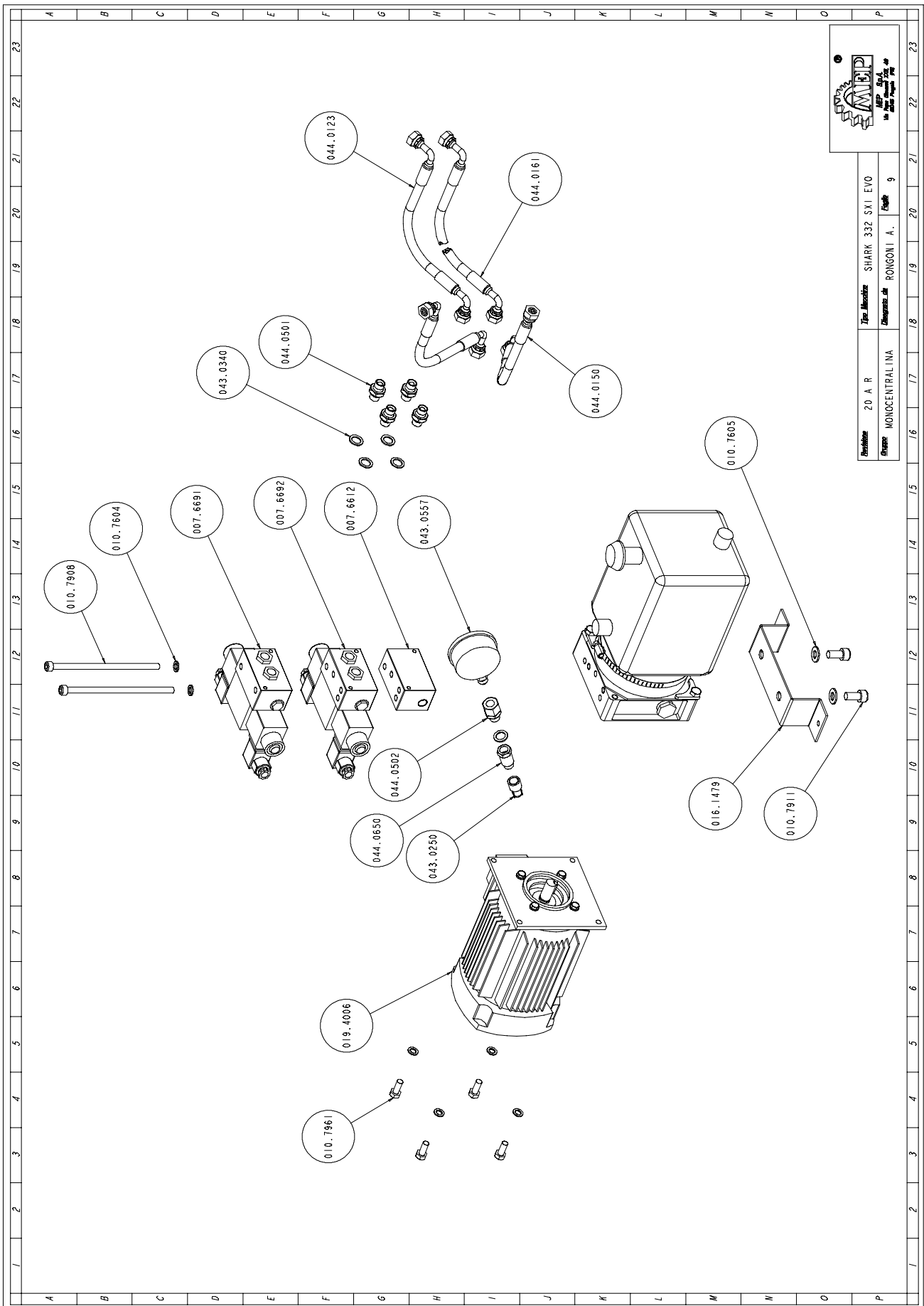

Modello	20 A R	Tip. Macchine	SHARK 332 SXI EVO
Gruppo	MONOCENTRALINA	Dimensioni di	RONGONI A. - Finito 9

Art. NR.	Benaming	M.	Hoeveelheid
007.6612	DISTANZIALE BLOCCHETTO IDRAULI	NR	1,000
007.6691	PANNELLO IDRAULICO TERMINALE C	NR	1,000
007.6692	PANNELLO IDRAULICO CENTRALE CE	NR	1,000
010.7604	RONDELLA DIAM. 8	NR	6,000
010.7605	RONDELLA DIAM. 10	NR	2,000
010.7908	VITE TCEI 8 X 50	NR	2,000
010.7911	VITE TCEI 10 X 20	NR	2,000
010.7961	VITE TE 8 X 20	NR	6,000
016.1479	STAFFA X ANCORAGGIO MONOCENTRA	NR	1,000
019.4006	MOTORE CENTRALINA HP 0,5 C71	NR	1,000
043.0250	GOMITO M.F. 1/4 CL 2020	NR	1,000
043.0340	RONDELLA RAME 13X19X1,5-1/4	NR	7,000
043.0557	MANOMETRO DIAM.60 WIKA	NR	1,000
044.0123	TUBO CENTRALINA IDRAULICA MM.5	NR	2,000
044.0150	TUBO CENTRALINA MM 370	NR	1,000
044.0161	TUBO CENTRALINA IDRAULICA MM.	NR	1,000
044.0501	NIPPLO NP 1/4 IDRAULICO	NR	4,000
044.0502	NIPPLO IDRAULICO GIREVOLE GMF	NR	1,000
044.0650	PROLUNGA 1/4 MF ES.36 MM.	NR	1,000

Handvat

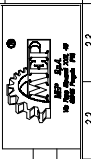
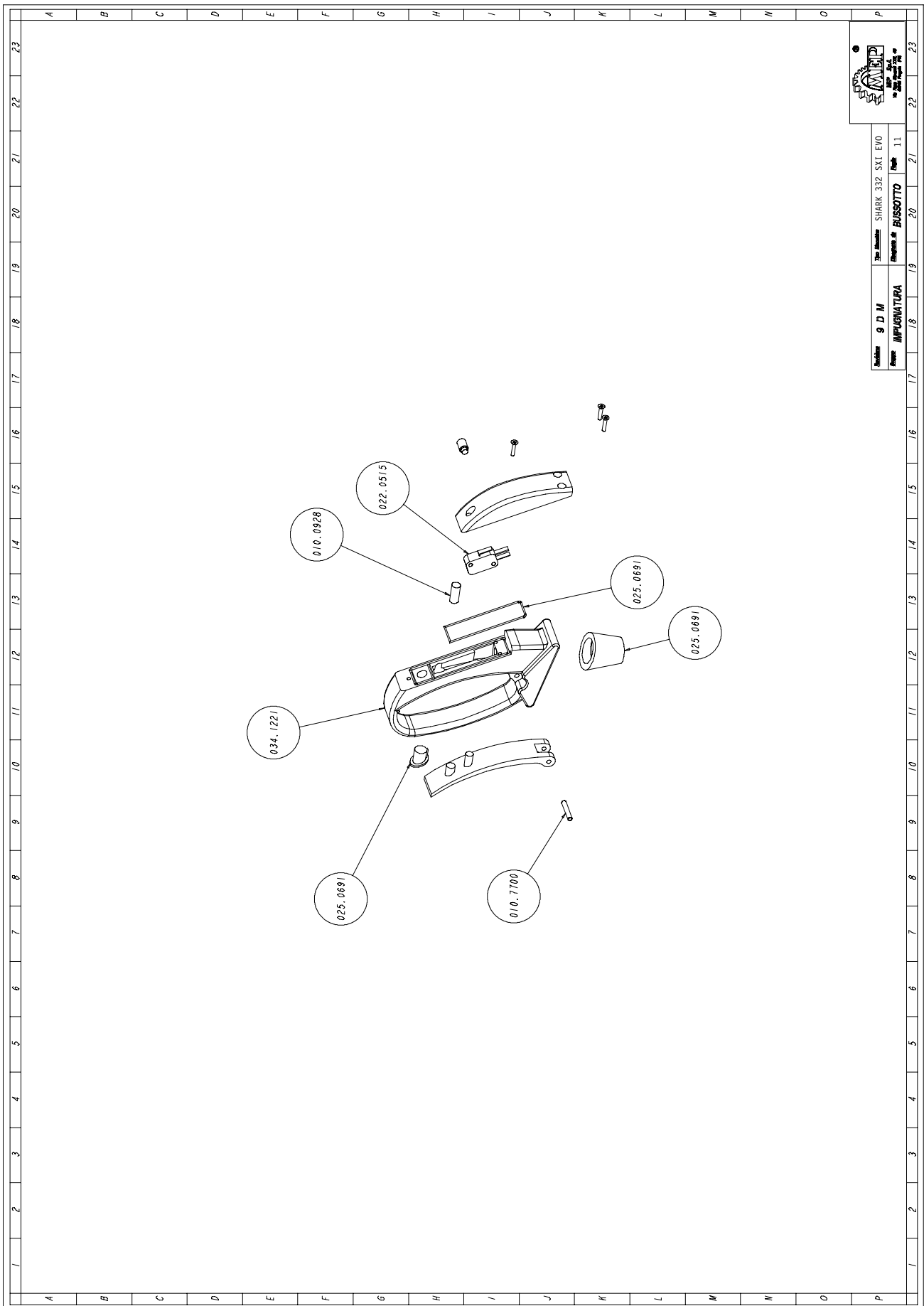

Modello **9 D M**
 Design **IMPUGNATURA**
 Tipo **SHARK 332 SXI EVO**
 Disegnato da **BUSOTTO** Scale **1:1**

Art. NR.	Benaming	M.	Hoeveelheid
010.0928	MOLLA X IMPUGNATURA	NR	1,000
010.7409	GRANO VCE P.CIL. 8 X 10	NR	1,000
010.7700	SPINA CILINDRICA DIAM. 4 X 24	NR	1,000
010.7800	VITE AUTOFILETTANTE 2,9 X 15	NR	3,000
022.0515	MICROINTERRUTTORE V-21-1C6	NR	1,000
025.0691	SERIE GUARNIZIONI X IMPUGNATUR	NR	1,000
034.1223	MANIGLIA MEP CON MOLLA-GUARNIZ	NR	1,000