

# Explosietekeningen

In het nu volgende deel zijn de explosietekeningen van de machine opgenomen. De tekeningen met hun volledige details kunnen helpen de machine beter te leren kennen.

## Hoofd eenheid

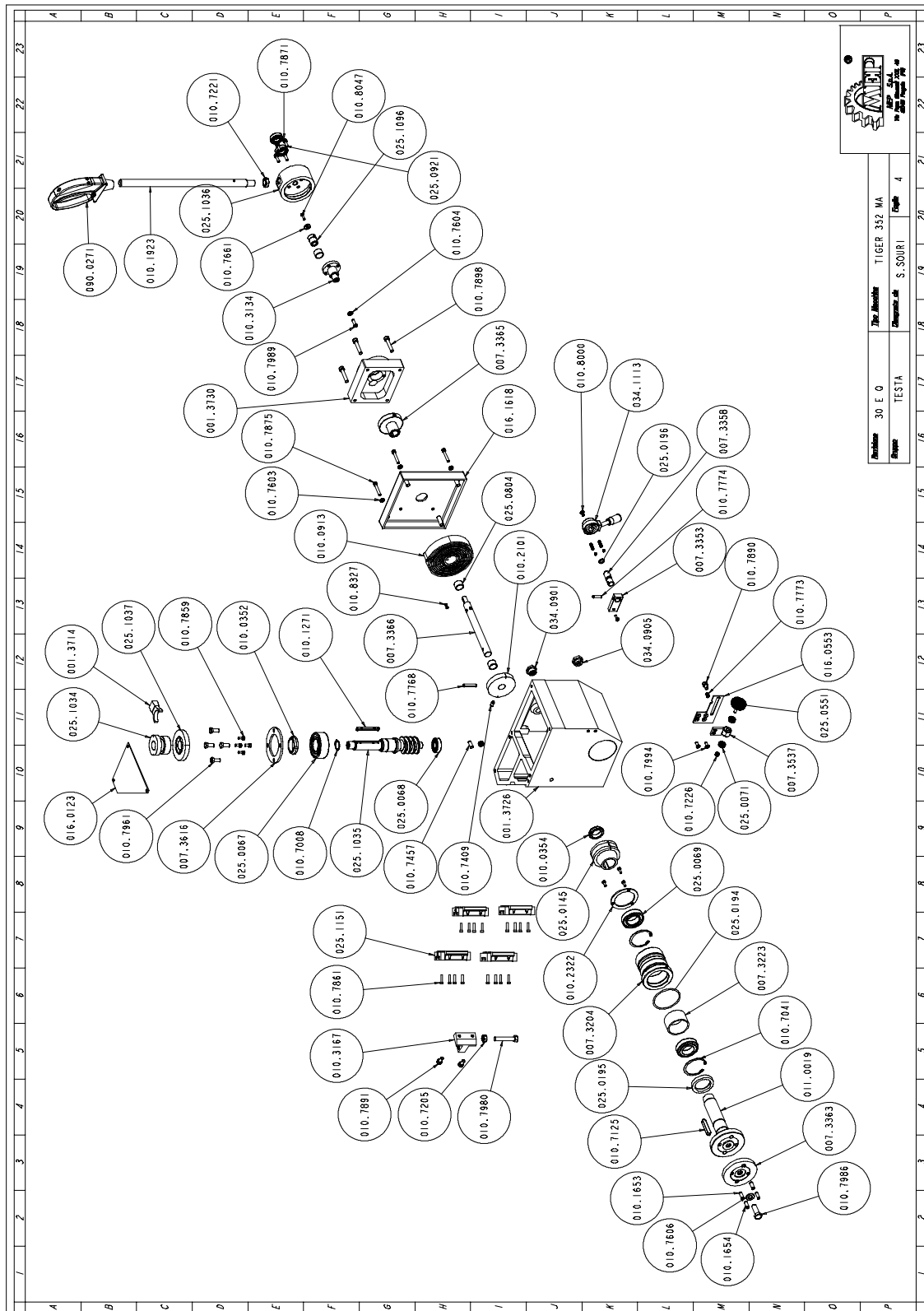

Art Nr	Benaming	M	Hoeveelheid
001.3714	FORCELLA CAMBIO	NR	1,000
001.3726	TESTA OPERATRICE TI 352 4 VEL	NR	1,000
001.3730	PIASTRA FISSAGGIO LEVA COMANDO	NR	1,000
007.3204	TAMPONE CUSCINETTI	NR	1,000
007.3223	ANELLO DISTANZIALE CUSCINETTO	NR	1,000
007.3353	PIASTRINO COMANDO CAMBIO	NR	1,000
007.3358	PERNO LEVA CAMBIO	NR	1,000
007.3363	FLANGIA ESTERNA TI 350 - 370	NR	1,000
007.3365	BOCCOLA RIPRESA CORSA TI 352-M	NR	1,000
007.3366	ALBERO MOVIMENTO TESTA TI 352	NR	1,000
007.3537	PIASTRINO PULILAMA TI	NR	1,000
007.3616	GHIERA FIX CUSCINETTO	NR	1,000
010.0352	GHIERA AUTOBLOCCANTE 35X1,5	NR	1,000
010.0354	GHIERA AUTOBLOCCANTE 30X1,5	NR	1,000
010.0913	MOLLA SOLLEVAMENTO TESTA	NR	1,000
010.0928	MOLLA X IMPUGNATURA	NR	1,000
010.1271	LINGUETTA 8X7X70 FORATA TI 350	NR	1,000
010.1653	PERNO FLANGIA	NR	2,000
010.1654	PERNO FLANGIA	NR	2,000
010.1923	LEVA COMANDO TESTA NORMALE TI	NR	1,000
010.2101	RUOTA SOLLEVAMENTO TESTA	NR	1,000
010.2322	FLANGIA BLOCCAGGIO CUSCINETTI	NR	1,000
010.3134	SUPPORTO LEVA COMANDO TESTA	NR	1,000
010.3167	BATTUTA FINE CORSA TESTA IN BA	NR	1,000
010.7008	ANELLO SEEGER DIAM. 25	NR	1,000
010.7041	ANELLO SEEGER PER FORI DIAM. 6	NR	2,000
010.7125	CHIAVETTA 10 X 8 X 56	NR	1,000
010.7204	DADO M8	NR	1,000
010.7205	DADO M10	NR	1,000
010.7221	DADO M16 BASSO	NR	1,000
010.7226	DADO AUTOBLOCCANTE M6	NR	1,000
010.7409	GRANO VCE P.CIL. 8 X 10	NR	1,000
010.7457	GRANO VCE P.CON. 8 X 20	NR	1,000
010.7603	RONDELLA DIAM. 6	NR	4,000
010.7604	RONDELLA DIAM. 8	NR	1,000
010.7606	RONDELLA DIAM. 12	NR	1,000
010.7661	RONDELLA SPESSORE DIAM. 6 X 3	NR	1,000
010.7700	SPINA CILINDRICA DIAM. 4 X 24	NR	1,000
010.7768	SPINA ELASTICA DIAM. 6 X 40	NR	1,000
010.7802	VITE AUTOFILETTANTE 3,9 X 16	NR	3,000
010.7859	VITE TCEI 5 X 12	NR	5,000
010.7861	VITE TCEI 5 X 20	NR	16,000
010.7871	VITE TCEI 6 X 20	NR	4,000
010.7875	VITE TCEI 6 X 40	NR	4,000
010.7890	VITE TCEI 8 X 12	NR	1,000
010.7891	VITE TCEI 8 X 16	NR	2,000
010.7898	VITE TCEI 8 X 45	NR	4,000
010.7957	VITE TE 5 X 12	NR	3,000
010.7961	VITE TE 8 X 20	NR	4,000
010.7980	VITE TE 10 X 60	NR	1,000
010.7986	VITE TE 12 X 35	NR	1,000
010.7989	VITE TSPEI 6 X 20	NR	1,000
010.7994	VITE TSPEI 6 X 12	NR	2,000
010.8000	VITE TSPEI 6 X 8	NR	1,000
010.8047	VITE TSPEI 5 X 16	NR	1,000
010.8327	CHIAVETTA 4 X 4 X 15	NR	1,000
011.0019	ALBERO PORTADISCO TI 350 CEME	NR	1,000
016.0123	CARTER TESTA TI 350 - MA N.T.	NR	1,000
016.0553	GUIDA SPAZZOLA PULILAMA	NR	1,000
016.1618	COPERCHIO MOLLA RICHIAMO TESTA	NR	1,000
022.0515	MICROINTERRUTTORE V-21-1C6	NR	1,000
025.0067	CUSCINETTO 3207	NR	1,000
025.0068	CUSCINETTO 6203	NR	1,000
025.0069	CUSCINETTO 32007X	NR	2,000
025.0071	CUSCINETTO 626 2RS	NR	2,000
025.0145	CORONA ELICOIDALE DIS. 86.06.0	NR	1,000
025.0194	ANELLO DI TENUTA OR 176 VITON	NR	1,000
025.0195	ANELLO DI TENUTA 45X62X10 G VI	NR	1,000
025.0196	ANELLO DI TENUTA OR 3043 VITON	NR	1,000
025.0551	SPAZZOLA PULILAMA 6X25 030 GG4	NR	1,000
025.0691	SERIE GUARNIZIONI X IMPUGNATUR	NR	3,000
025.0804	BOCCOLA GRAFITATA L. 15 DIAM.	NR	3,000
025.0921	CUSCINETTO 6003 2Z	NR	2,000
025.1034	RUOTA DENTATA 43007/53 ALBERO	NR	1,000
025.1035	ALBERO VITE SENZA FINE 43003/5	NR	1,000
025.1036	RUOTA DENTATA ALBERO MOVIMENTO	NR	1,000
025.1037	RUOTA DENTATA 43005/53 ALBERO	NR	1,000
025.1096	PIGNONE ALBERO MOVIMENTO TESTA	NR	1,000
025.1151	PATTINO LGW20HAZ1C	NR	4,000
034.0901	TAPPO LIVELLO OLIO 1/2 "GAS.	NR	1,000
034.0905	TAPPO OLIO TAO/3 1/2" NERO	NR	1,000
034.1113	VOLANTINO DI MANOVRA	NR	1,000
090.0271	IMPUGNATURA COMPLETA TIPO MEP	NR	1,000

## Handvat bedieningshendel zaagbeugel

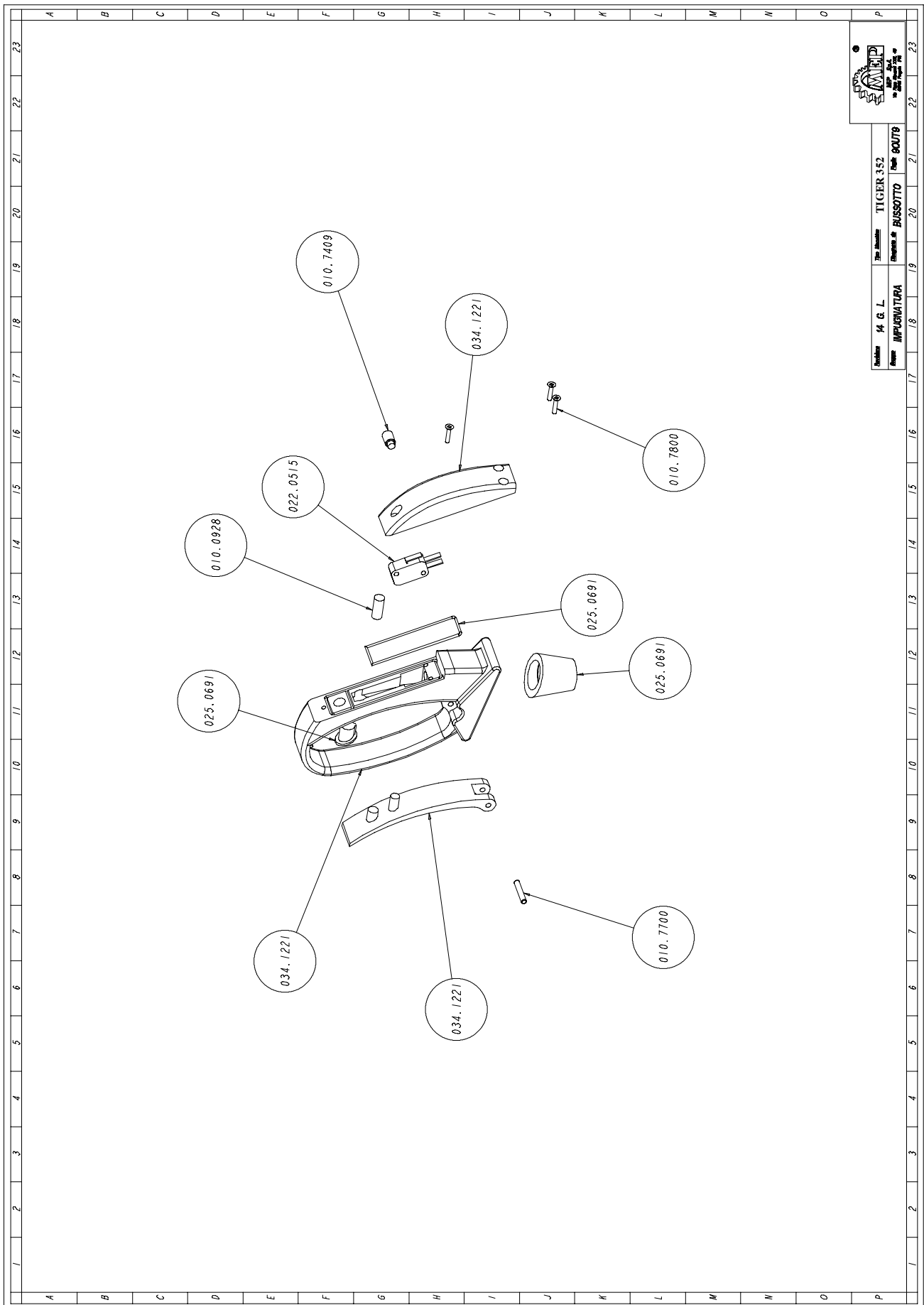

---

<b>Art. Nr.</b>	<b>Benaming</b>	<b>M.</b>	<b>Hoeveelheid</b>
010.0928	MOLLA X IMPUGNATURA	NR	1,000
010.7409	GRANO VCE P.CIL. 8 X 10	NR	1,000
010.7700	SPINA CILINDRICA DIAM. 4 X 24	NR	1,000
010.7800	VITE AUTOFIL. 2,9 X 15	NR	3,000
022.0515	MICROINTERRUTTORE V-21-1C6	NR	1,000
025.0691	SERIE GUARNIZIONI X IMPUGNATURA MEP	NR	1,000
034.1221	IMPUGNATURA DIS. MEP	NR	1,000

# Zaagmotor

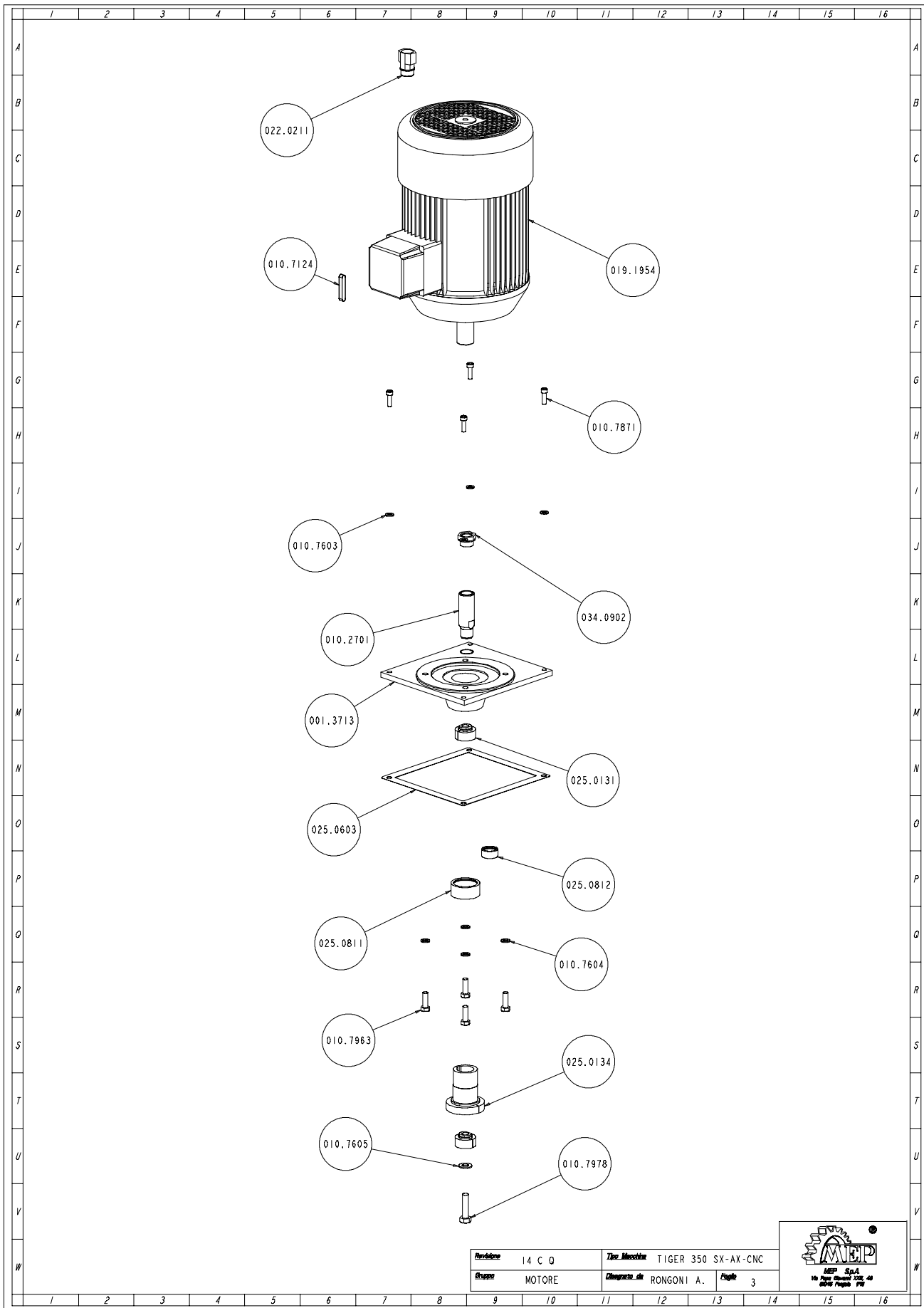

<b>Art. Nr.</b>	<b>Benaming</b>	<b>M.</b>	<b>Hoeveelheid</b>
001.3713	COPERCHIO SUPERIORE TESTA	NR	1,000
010.2701	PROLUNGA TAPPO OLIO TI 350	NR	1,000
010.7124	CHIAVETTA 8 X 7 X 45	NR	1,000
010.7603	RONDELLA DIAM. 6	NR	4,000
010.7604	RONDELLA DIAM. 8	NR	4,000
010.7605	RONDELLA DIAM. 10	NR	1,000
010.7871	VITE TCEI 6 X 20	NR	4,000
010.7963	VITE TE 8 X 25	NR	4,000
010.7978	VITE TE 10 X 40	NR	1,000
019.1954	KW 2,6/1,84 8/4P.C112 B.14 V.3	NR	1,000
022.0211	RACCORDO RAPIDO SEM PG 13,5	NR	1,000
025.0131	RUOTA DENTATA 43004/53 ALB. MO	NR	1,000
025.0134	RUOTA DENTATA 43006/53 ALB.MOT	NR	1,000
025.0603	GUARNIZIONE TESTA 4 VEL.	NR	1,000
025.0811	BOCCOLA A RULLINI DHK 4020 HK	NR	1,000
025.0812	BOCCOLA A RULLINI DHK 2012 HK	NR	1,000
034.0902	TAPPO OLIO SFP 1/2" ROSSO	NR	1,000

## Bedieningspaneel

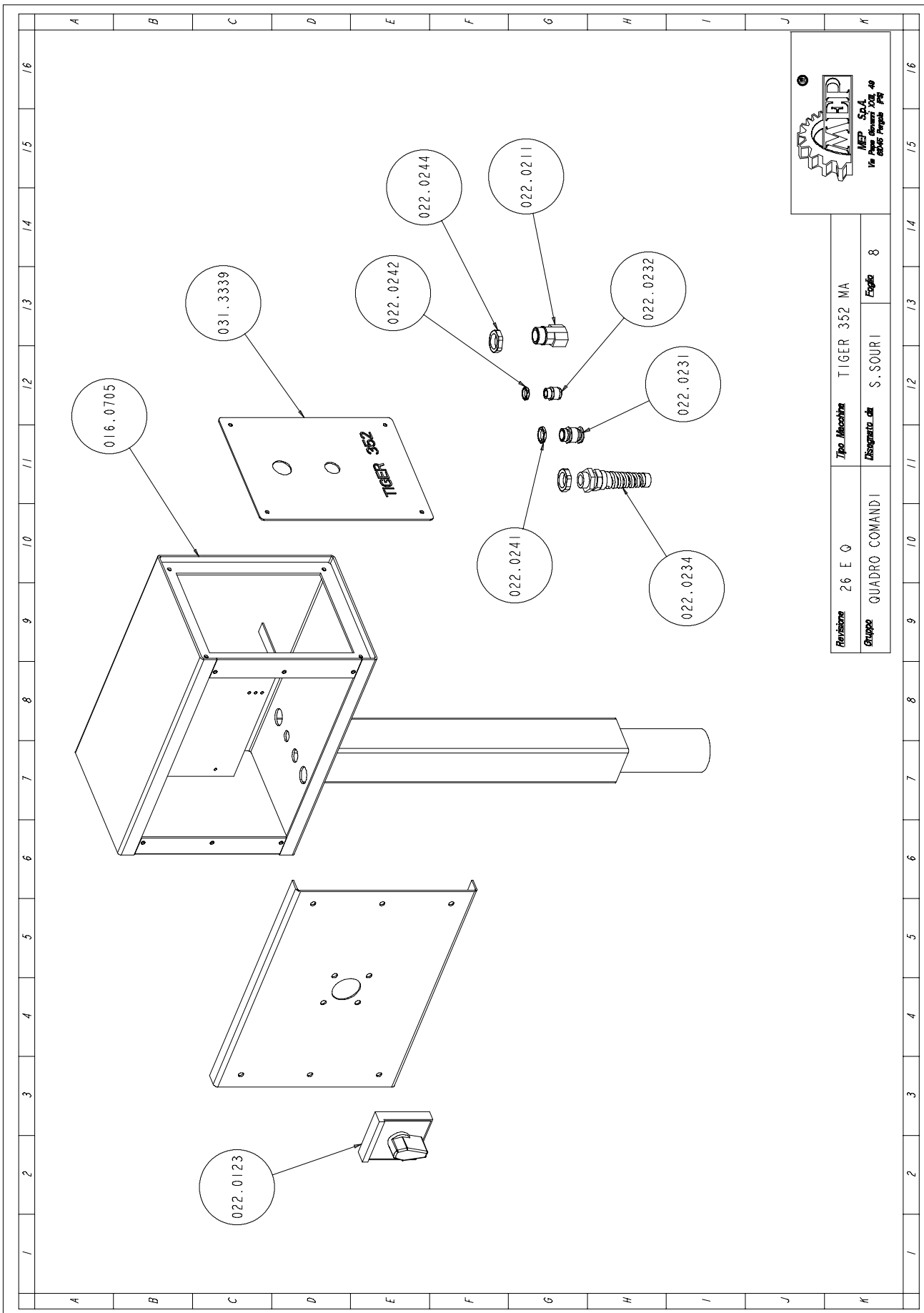

Revisi3n	26 E 0	Tipo_Macchina	TIGER 352 MA
Gruppo	QUADRO COMANDI	Disegnato da	S. SOURI
		Foglio	8



<b>Art. Nr.</b>	<b>Benaming</b>	<b>M.</b>	<b>Hoeveelheid</b>
016.0705	QUADRO COMANDI LVD	NR	1,000
022.0123	COMANDO BLOCCOPORTA LUCCHETTAB	NR	1,000
022.0211	RACCORDO RAPIDO SEM PG 13,5	NR	1,000
022.0231	PRESSACAVO IN OTTONE 3/8 BM 24	NR	1,000
022.0232	PRESSACAVO IN OTTONE 1/4 BM 24	NR	1,000
022.0234	PRESSACORDONE 3246 NERO PG 13,	NR	1,000
022.0241	DADO IN OTTONE BM 2461 3/8	NR	1,000
022.0242	DADO IN OTTONE BM 2460 1/4	NR	1,000
022.0244	CONTRODADO 3217B GRIGIO PG 13	NR	2,000
031.3339	TARGA INTERRUETTORE TI 352	NR	1,000



# Klem

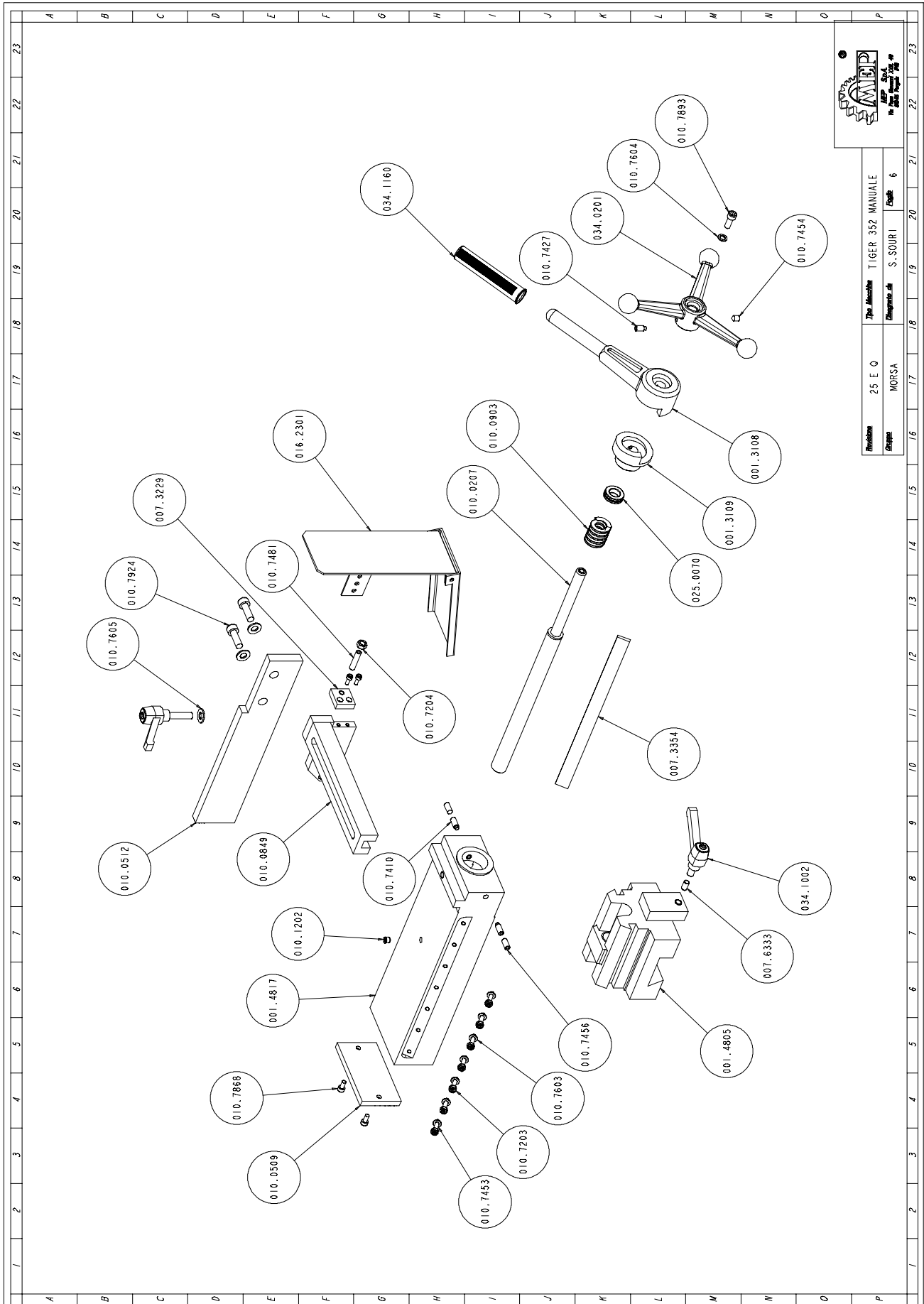

Art. Nr.	Benaming	M.	Hoeveelheid
001.3108	LEVA BLOCCAGGIO MORSA RAPIDA	NR	1,000
001.3109	BOCCOLA A CAMME	NR	1,000
001.4805	SUPPORTO MORSA M	NR	1,000
001.4817	.SCORREVOLE MORSA TI 370 SX	NR	1,000
007.3229	TASSELLO X BATTUTA SCORR. ANTI	NR	1,000
007.3354	LARDONE MORSA	NR	1,000
007.6333	PERNO BLOCCAGGIO MORSA TI 370	NR	1,000
010.0207	VITE MORSA	NR	1,000
010.0509	GANASCIA MORSA	NR	1,000
010.0512	GANASCIA ANTIBAVA	NR	1,000
010.0849	SUPPORTO SCORREVOLE GANASCIA A	NR	1,000
010.0903	MOLLA MORSA RAPIDA	NR	1,000
010.1202	OLIATORE A SFERA DIAM. 8	NR	1,000
010.7203	DADO M6	NR	7,000
010.7204	DADO M8	NR	1,000
010.7410	GRANO VCE P.CIL. 8 X 16	NR	2,000
010.7427	GRANO VCE P.CIL. 8 X 12	NR	1,000
010.7453	GRANO VCE P.CON. 6 X 30	NR	7,000
010.7454	GRANO VCE P.CON. 8 X 8	NR	1,000
010.7456	GRANO VCE P.CON. 8 X 16	NR	2,000
010.7481	GRANO VCE PUNTA PIANA 8 X 35	NR	1,000
010.7491	GRANO VCE PUNTA PIANA 10 X 60	NR	1,000
010.7603	RONDELLA DIAM. 6	NR	7,000
010.7604	RONDELLA DIAM. 8	NR	1,000
010.7605	RONDELLA DIAM. 10	NR	3,000
010.7859	VITE TCEI 5 X 12	NR	2,000
010.7868	VITE TCEI 6 X 12	NR	2,000
010.7893	VITE TCEI 8 X 20	NR	3,000
010.7924	VITE TCEI 10 X 30	NR	2,000
010.9074	GRANO VCE PUNTA PIANA 10 X 20	NR	1,000
016.2301	RACCOGLITORE ACQUA MORSA TI 35	NR	1,000
025.0070	CUSCINETTO 51103	NR	1,000
034.0201	VOLANTINO MORSA GRANDE	NR	1,000
034.1002	LEVA A SCATTO 10 MA	NR	2,000
034.1160	MANOPOLA MOD. 1014 0 20	NR	1,000

### Draaitafel

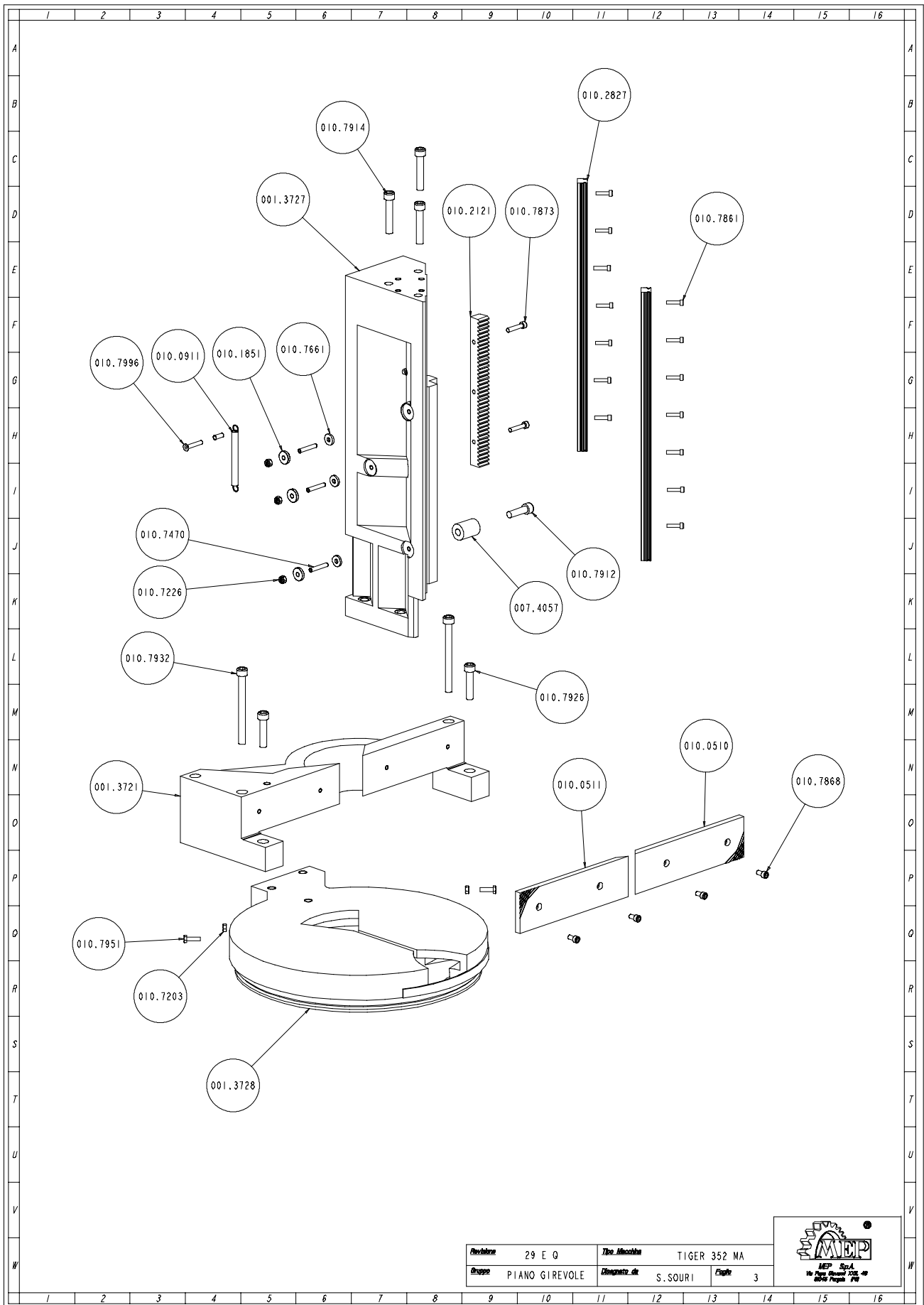

Modello	29 E Q	Tip. Macchine	TIGER 352 MA
Gruppo	PIANO GIREVOLE	Disegnato da	S.SOURI
		Foglio	3



<b>Art. Nr.</b>	<b>Benaming</b>	<b>M.</b>	<b>Hoeveelheid</b>
001.3721	SQUADRO MORSA	NR	1,000
001.3727	.COLONNA PORTANTE TI 352	NR	1,000
001.3728	PIATTAFORMA GIREVOLE TI 350 N.	NR	1,000
007.4057	BOCCOLA BATTUTA FINE CORSA	NR	1,000
010.0510	GANASCIA MORSA DESTRA	NR	1,000
010.0511	GANASCIA MORSA SINISTRA	NR	1,000
010.0911	MOLLA RICHIAMO CARTER DISCO	NR	1,000
010.1851	BOCCOLA PER CARTER DISCO -DIAM	NR	3,000
010.2121	CREMAGLIERA	NR	1,000
010.2827	GUIDA PATTINO HGW 20 HC 2 R 43	NR	2,000
010.7203	DADO M6	NR	2,000
010.7226	DADO AUTOBLOCCANTE M6	NR	3,000
010.7470	GRANO VCE PUNTA PIANA 6 X 35	NR	3,000
010.7661	RONDELLA SPESSORE DIAM. 6 X 3	NR	3,000
010.7861	VITE TCEI 5 X 20	NR	14,000
010.7868	VITE TCEI 6 X 12	NR	4,000
010.7873	VITE TCEI 6 X 30	NR	2,000
010.7912	VITE TCEI 10 X 35	NR	1,000
010.7914	VITE TCEI 10 X 55	NR	3,000
010.7926	VITE TCEI 10 X 45	NR	2,000
010.7932	VITE TCEI 10 X 110	NR	2,000
010.7951	VITE TE 6 X 20	NR	2,000
010.7996	VITE TSPEI 6 X 30	NR	1,000

### Vaste tafel

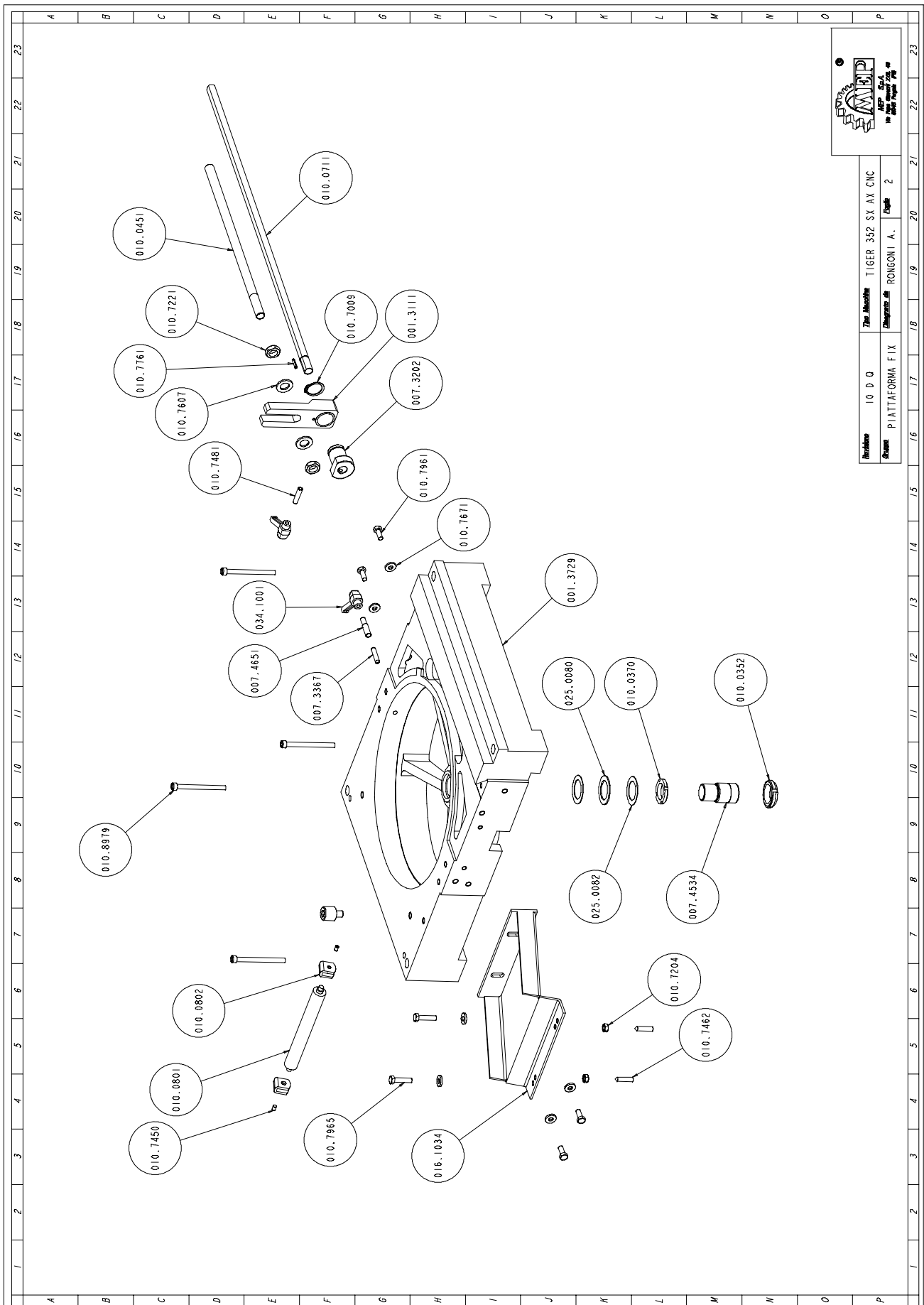

<b>Art. Nr.</b>	<b>Benaming</b>	<b>M.</b>	<b>Hoeveelheid</b>
001.3111	DISTANZIALE BATTUTA	NR	1,000
001.3729	PIATTAFORMA FISSA	NR	1,000
007.3202	BOCCOLA X BATTUTA	NR	1,000
007.3367	PERNO BLOCCAGGIO PIANO GIREVOL	NR	1,000
007.4534	PERNO DI CENTRO	NR	1,000
007.4651	GRANO BLOCCAGGIO PIANO ROTANTE	NR	1,000
010.0311	VITE TCEI M12X16 BATT.PIANO GI	NR	2,000
010.0352	GHIERA AUTOBLOCCANTE 35X1,5	NR	1,000
010.0370	GHIERA 5S 30X1,5	NR	1,000
010.0451	TIRANTE BATTUTA TAGLI MISURA	NR	1,000
010.0711	ASTA MILLIM.CROMATA MM.600 FIL	NR	1,000
010.0801	RULLO TIPO	NR	1,000
010.0802	SUPPORTO PER RULLO	NR	2,000
010.7009	ANELLO SEEGER DIAM. 30	NR	1,000
010.7204	DADO M8	NR	2,000
010.7221	DADO M16 BASSO	NR	2,000
010.7450	GRANO VCE P.CIL. 6 X 6	NR	2,000
010.7462	GRANO VCE P.CON. 8 X 30	NR	2,000
010.7481	GRANO VCE PUNTA PIANA 8 X 35	NR	1,000
010.7607	RONDELLA DIAM. 16	NR	2,000
010.7671	RONDELLA SPESSORE DIAM. 8 X 3	NR	6,000
010.7761	SPINA ELASTICA DIAM. 4 X 20	NR	1,000
010.7961	VITE TE 8 X 20	NR	4,000
010.7965	VITE TE 8 X 35	NR	2,000
010.8979	VITE TCEI 8 X 95	NR	4,000
016.1034	BRACCETTO APPOGGIA BARRA	NR	1,000
025.0080	GABBIA ASSIALE A RULLINI AXK 3	NR	1,000
025.0082	RALLA AS 3552	NR	2,000
034.1001	LEVA A SCATTO 8 MA PK55	NR	2,000

## Eenheid ter afdekking zaagblad

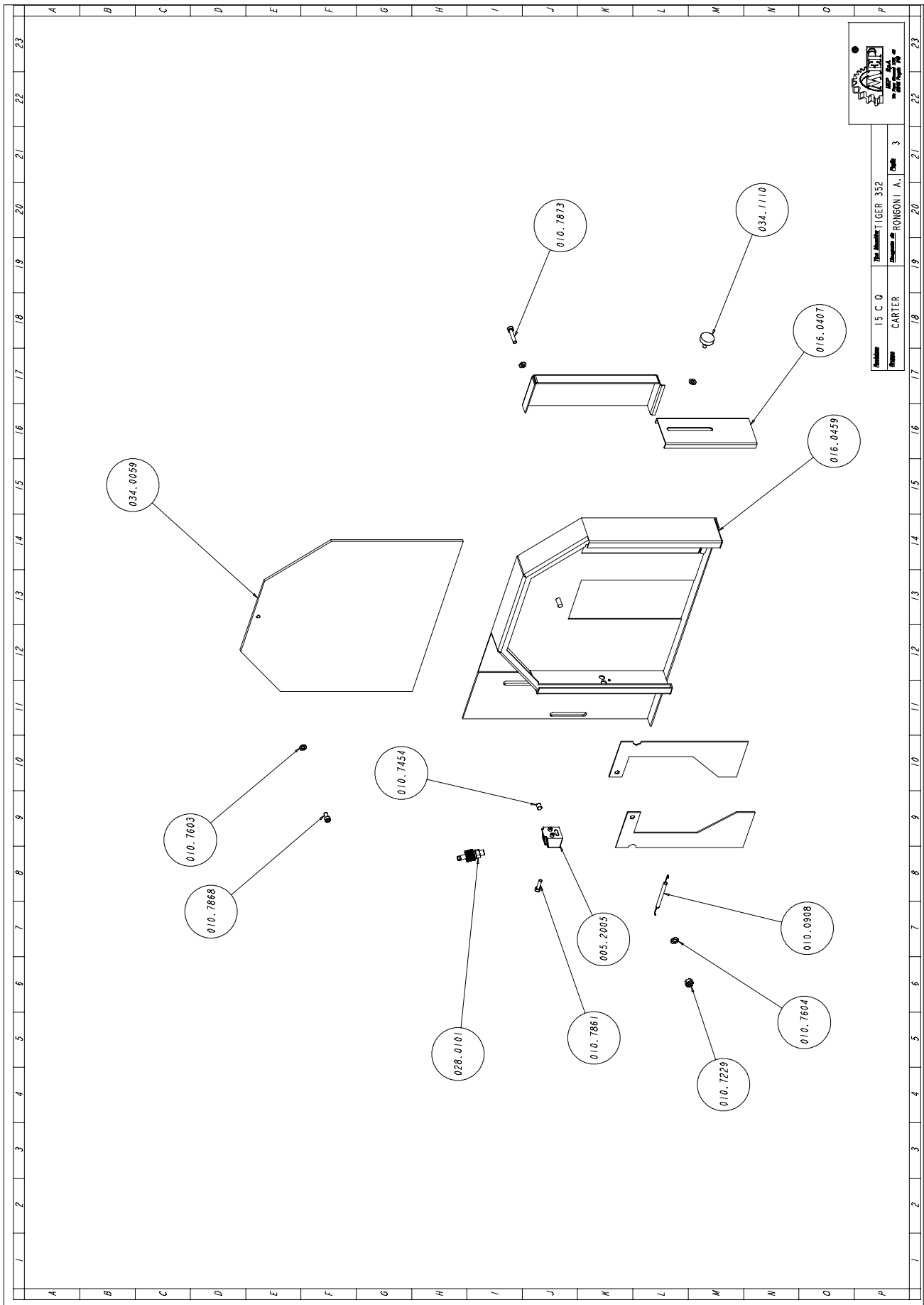

<b>Art. Nr.</b>	<b>Benaming</b>	<b>M.</b>	<b>Hoeveelheid</b>
005.2005	SPRUZZATORE RUBINETTO	NR	1,000
010.0908	MOLLA CARTER DISCO	NR	1,000
010.7229	DADO AUTOBLOCCANTE M8	NR	1,000
010.7454	GRANO VCE P.CON. 8 X 8	NR	1,000
010.7603	RONDELLA DIAM. 6	NR	3,000
010.7604	RONDELLA DIAM. 8	NR	1,000
010.7861	VITE TCEI 5 X 20	NR	1,000
010.7868	VITE TCEI 6 X 12	NR	1,000
010.7873	VITE TCEI 6 X 30	NR	1,000
016.0407	PARASCHIZZI ANTERIORE	NR	1,000
016.0459	CARTER DISCO	NR	1,000
028.0101	REGOLATORE PER RUBINETTO 8 X 1	NR	1,000
034.0059	PROTEZ.LEXAN TI 350 + AD.SCELT	NR	1,000
034.1110	VOLANTINO DIAM.30 M6 X 10	NR	1,000



# Onderstel

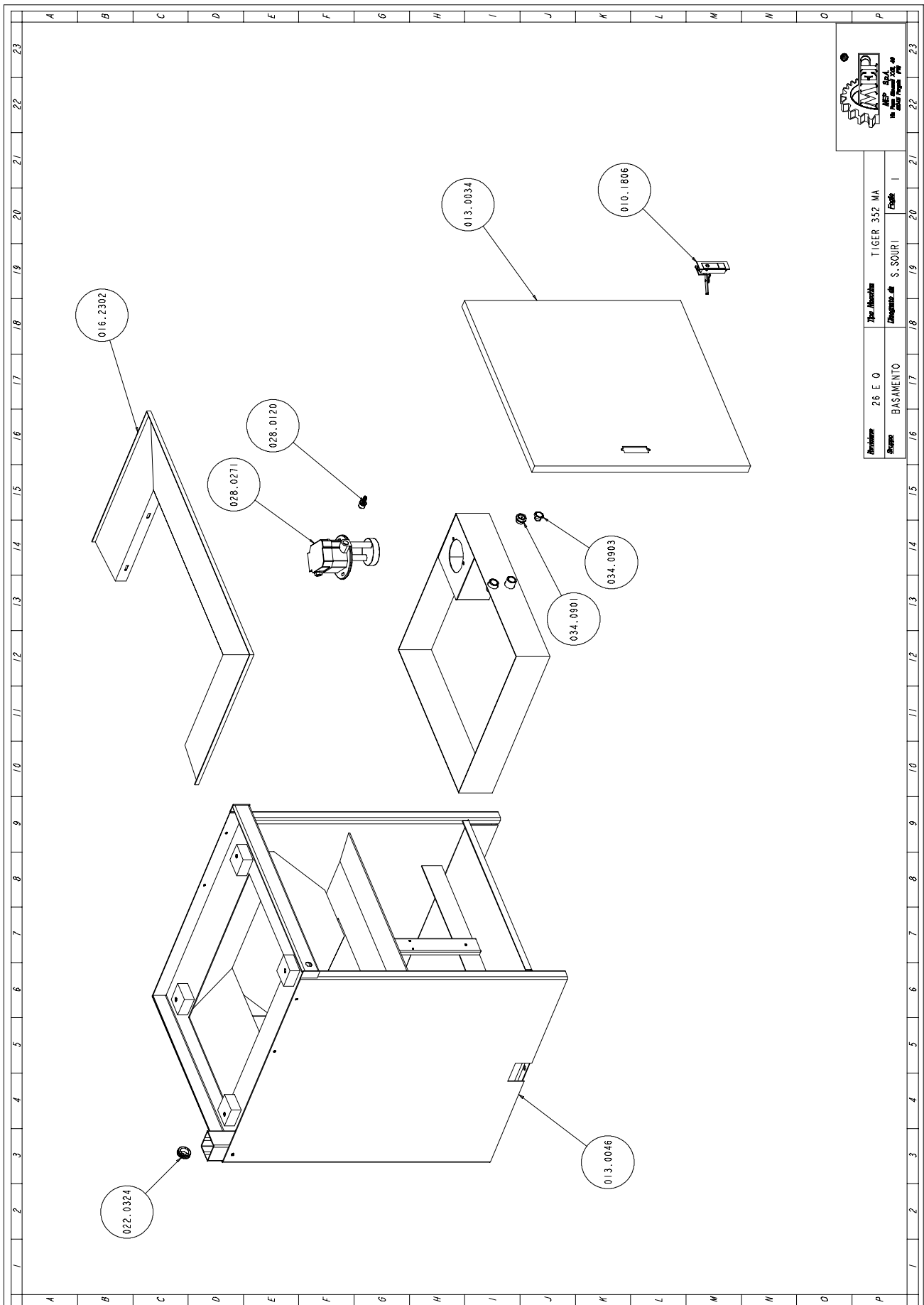

		Revisie	26 E Q	Titel	TIGER 352 MA
		Stap	BASAMENTO	Ontworpen door	S. SOURI
				Bladzijde	1
				Totaal bladzijden	1

<b>Art. Nr.</b>	<b>Benaming</b>	<b>M.</b>	<b>Hoeveelheid</b>
010.1806	CHIUSSURA SPORTELLO PIEDISTALLO	NR	1,000
013.0046	PIEDISTALLO TI 352 - 352 SX	NR	1,000
016.2302	RACCOGLITORE ACQUA TI 352 - SX	NR	1,000
022.0324	PASSACAVI 24 INC.MM.2.5	NR	1,000
028.0120	RACCORDO 3/8 - 9 CL 2601	NR	1,000
028.0271	ELETTROPOMPA EZ/C V. 220-380	NR	1,000
034.0901	TAPPO LIVELLO OLIO 1/2 "GAS.	NR	1,000
034.0903	TAPPI OLIO 3/8" GAS	NR	1,000